

# SEA TECHNOLOGY

EXPERTS IN DIAMOND TOOLS, SINCE 1973



GENERAL  
CATALOGUE  
2025

SLAFLOOR 450





CARLO ANCELOTTI  
FOR

**SEA TECHNOLOGY**  
EXPERTS IN DIAMOND TOOLS, SINCE 1973



[www.seatechnology.eu](http://www.seatechnology.eu)





SEA Technology is the Maxima Group's company specialising in the production and sale of diamond tools and construction machinery for professional cutting and core drilling, aimed primarily at a market of professional users, such as specialised construction equipment dealers, controlled demolition companies, industrial floor cutting companies and prefabricated building manufacturers.

For over 40 years, SEA Technology has offered its customers a personalised service and a wide range of products dedicated to professionals. One of SEA Technology's strengths is the continuous research and consequent development of new products, always aiming to meet the new demands of a constantly evolving market and characterised by high quality, guaranteed by the numerous tests carried out in-house to certify that each system complies with the most stringent regulations and fully meets the needs of the professional operator.

# DISPLAY SOLUTIONS

If it is true that 'you buy first with your eyes', then the significant resources SEA Technology invests in sales outlets are confirmed: displays, banners, flags, flyers, etc., to make the product and the company visible.

A comprehensive exhibition is the precursor to the Demonstration Day, a great vehicle for promotion and customer loyalty. In addition, the display enhances and professionalises the sales outlet, greatly increasing the credibility of the retailer's message to the end user and also allowing the range of products to be available in higher rotation to meet 'emergency sales'.



# WERENT<sup>®</sup>

WERENT is SEA Technology's equipment and tool rental programme. Developed for the specific cutting, coring, sanding and other applications of construction and plant engineering companies, WERENT is supplied to dealers as a turnkey package of products and services.

The retailer displaying the WERENT brand receives everything necessary to offer the rental equipment correctly: from forms and price lists to communication, including flags, roll-ups and flyers. We offer dry and wet core drills for reinforced concrete, power cut-off saws, floor saws, site cutters with blade and belt, manual and frame grinders, as well as a vast range of diamond tools for most uses in these application areas.

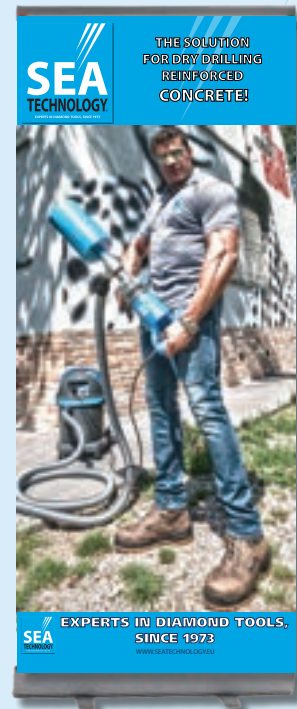
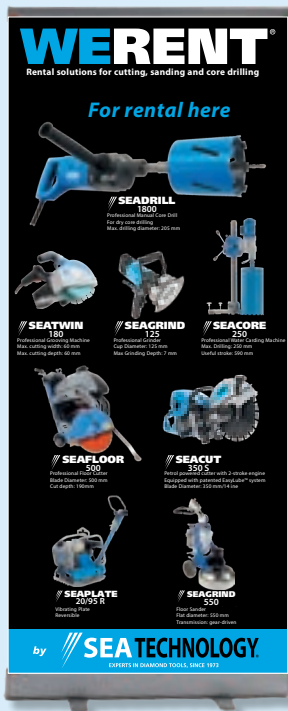

## The virtuous circle of rental

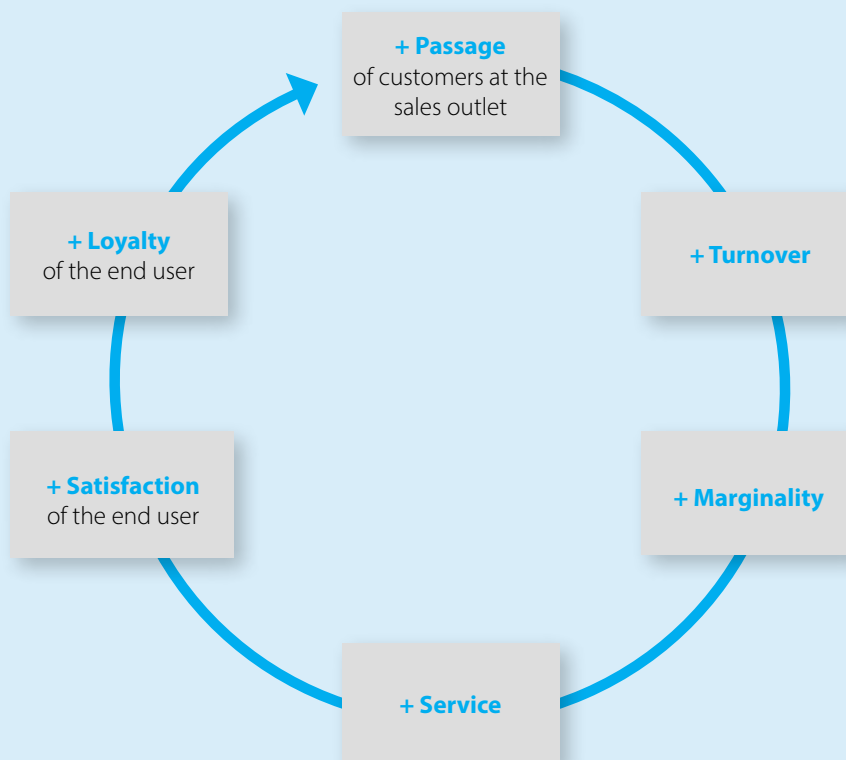

# INDEX

## SPECIFIC BLADES

CEMENTO FRESCO CINQUE	10	CEMENTO QUATTRO SILENT	11	ASFALTO CINQUE SILENT	13
CEMENTO FRESCO TRE LASER	10	CEMENTO TRE SILENT	12	ASFALTO QUATTRO SILENT	13
CEMENTO FRESCO DUE LASER	11	CEMENTO DUE SILENT	12	ASFALTO TRE SILENT	13
CEMENTO SEI SILENT	11	CEMENTO UNO SILENT	12	ASFALTO UNO SILENT	13
CEMENTO CINQUE SILENT	11	CEMAS	12		

## UNIVERSAL LASER BLADES

LASER NOVE	14	LASER QUATTRO	15	CANTIERE TRE SILENT	16
LASER CINQUE	14	LASER TRE	15	LASER SCAN QUATTRO	16
LASER QUATTRO SILENT	15	LASER DUE	16		

## UNIVERSAL TURBO BLADES

TURBO SEI	17	TURBO TRE	18
TURBO QUATTRO	17	TURBO DUE	18

## BLADES FOR CERAMIC

CER SETTE TURBO	19	CER QUATTRO	20
CER CINQUE TURBO	19	CER TRE	20
CER CINQUE LASER	20	CER DUE	21

## BLADES FOR STONE AND SPECIALS

PORFIDO SEI SILENT	22	ELETTO TRE	23	EMERGENZA CINQUE	24
GRANITO CINQUE SILENT	22	MARMO QUATTRO SILENT	23	MULTICUT QUATTRO	24
REFRATTARI CINQUE	23	METALLO CINQUE	24		

## CUTTING CONSTRUCTION MACHINERY

SEATWIN 180	25	SEATABLE 400	26	SEATABLE 701	27
SEATABLE 200 PONTE	25	SEATABLE 401	26	SEATABLE 1001	27
SEATABLE 400 PONTE	26	SEATABLE 700	27	SEABAND 500	28

## CUT-OFF SAW AND FLOOR SAW

SEACUT 350 SPECIAL	29	SEAFLOOR 500 S	31	SEAFLOOR 801 D	32
SEAFLOOR 350	30	SEAFLOOR 501	31	SEAFLOOR 500 E	33
SEAFLOOR 450	30	SEAFLOOR 600	31	SEAFLOOR 801 E	33
SEAFLOOR 500	30	SEAFLOOR 600 A	32	SEAFLOOR 1001E/ES	33

## HIGH FREQUENCY

SEACUT 400A ring	34	SEASAW 40	35	SEACUT 900S	37
SEACUT 400HF blade	34	SEADRILL 3700HF	36	SEACUT 900FU15D	37
SEACUT 450S rail	35	SEADRILL 3700HFRIG	36		
SEACUT 500S rail	35	SEACUT 400HF6D	36		

## WATER DIAMOND CROWNS

CORONA TRE 450	38	CORONA DUE 450 brazed	39	FAST CONTINUOUS CORING	40
CORONA TRE 450 1/2 Gas	39	CORONA UNO 450	40		
CORONA DUE 450	39	CONTINUOUS CORING	40		

## DIAMOND DRY CROWNS

CORONA TRE 300 DUST SUCTION SYSTEM	41	CORONA DUE 150	42
CORONA TRE 150	41	CORONA DUE 45 GRES	42



## CORING CONSTRUCTION MACHINERY

SEADRILL 1800	43	SEADRILL 300	45	SEACORE 350 P	48
SEADRILL 1600 A	43	SEADRILL 350	46	SEACORE 400	48
SEADRILL 2000 A	44	SEADRILL 400	46	SEACORE 500	48
SEADRILL 2000	44	SEACORE 200	46	SEACORE 600	49
SEADRILL 200 ASP	44	SEACORE 200 ASP	47	SEACORE 1000	49
SEADRILL 200	45	SEACORE 250	47		
SEADRILL 250	45	SEACORE 350	47		

## CORING EQUIPMENT

SEASTAND 200	50	PSTAND 250	50	SEASTAND 250/400	51
SEASTAND 250	50	PSTAND 400	50	SEAPIPE	51
SEASTAND 300	50	PSTAND 600	50	SEALIFTER	52
SEASTAND 400	50	PSTAND 1000	51		
PSTAND 200	50	SEASTAND 250 DELUXE	51		

## SEM AND SSR MOTORS

SEM 26 MOTOR	53	SEM 52 MOTOR	54	SSR65 MOTOR	54
SEM 32 / 32P MOTOR	53	SSR25 MOTOR	54	SSR68 MOTOR	54
SEM 42 MOTOR	53	SSR38 MOTOR	54	SSR75 MOTOR	54

## CORING ACCESSORIES

SEAPLATFORM	55	PPIPE	55	PLUGS AND BUSHINGS	56
SEAWALL	55	SDS AND CYL. CENTRING BITS	56	TOOL DRESSING STONE	56
SEADUST KIT	55	SDS AND HEXAGONAL FITTINGS	56	CENTRING PISTON	56
WATER COLLECTOR COVER	55	EXTENSIONS	56	PORTABLE TANK	56
SEAVACUUM	55	ADAPTERS AND QUICK ADAPTERS	56	TANK WITH ELECTRIC PUMP	56

## CUTTING AND GRINDING ACCESSORIES

SEACOVER T115 - T125 - T230	57	JOLLY T115 - T125	57	CORE BIT CENTRING	57
SLIDER T115 - T125	57	SEACOVER 82 AND 162	57	SEACOVER L125 - L180	57

## DUST SUCTION SYSTEM

SEACLEAN 25 / 25M	58	SEACLEAN 220 IC	59	SEACLEAN 600	59
SEACLEAN 50	58	SEACLEAN 360	59		

## CUPS

PLATO DIECI RESINA	60	PLATO SEI FAST	61	PLATO QUATTRO STANDARD	62
PLATO NOVE	60	PLATO CINQUE STANDARD	62	PLATO TRE	63
PLATO SETTE RESINA / CEMENTO	61	PLATO QUATTRO FAST	62	PLATO DUE	63

## DIAMOND GRINDING AND POLISHING MODULES

GRINDER GIALLO PCD	64	GRINDER GIALLO	64	GRINDER FOR SANDERS	65
--------------------	----	----------------	----	---------------------	----

## SURFACE REMOVAL MACHINES

SEAPRECUT	66	SEASTRIPPER 100	67	ACCESSORIES FOR SCRAPERS	67
SEASTRIPPER 15	66	SEASTRIPPER 200	67		

## SURFACE PREPARATION MACHINES

SEASCAR 200/265	69	SEAGRIND 280 / 550	70		
SEAGRIND 125	69	SEAPOLISH 480	70		

## COMPACTION

SEARAMMER 80 / 80D	71	SEAPLATE 24/115	72	SEAPLATE 26/160 R	73
SEAPLATE 12/60	72	SEAPLATE 22/140	73	SEAPLATE 32/210 R	74
SEAPLATE 18/95	72	SEAPLATE 20/95 R	73	SEAPLATE 42/250 R	74

## CONTROLLED DEMOLITION

TAGLIOMURO DIECI	75	DIAMOND SINTERED WIRE	76	TAGLIO PREFABBRICATO DIECI	77
TAGLIOMURO OTTO SEA3D	76	ELECTROPLATED DIAMOND WIRE	77	TAGLIO TRAVETTI DIECI	78
TAGLIOMURO CINQUE	76	CONCRETE/ASPHALT DIAMOND BLADE FOR GROOVES	77	SEGMENTO FORETTO SEI	78

## DECONSTRUCTION ACCESSORIES

SEAFIX	79	SEALIFT	80	SEACEI	80
--------	----	---------	----	--------	----

# SPECIFIC BLADES

## CEMENTO FRESCO CINQUE

The best available on the market among brazed blades for cutting fresh concrete. The diamond segment is suitable for water cutting on concrete surfaces laid between **24 and 48 hours**. Under the name CF1, this blade has been in our catalogue since 1998.

AVAILABLE  
Ø 300 - 350 - 400



## CEMENTO FRESCO TRE LASER

The diamond segments are laser-welded; the blade is suitable for water cutting on concrete surfaces laid between **24 and 48 hours**. This tool is a good compromise between cutting speed and output.

AVAILABLE  
Ø 300 - 350



# CEMENTO FRESCO DUE LASER

Top in the market for blades with laser-welded segments for cutting fresh concrete. The blade is suitable for water cutting on concrete surfaces laid for more than **48 hours**. The special composition of the segment and its design make cutting very fast and very precise. Excellent for laser screeded floors (laser vibrated).

AVAILABLE  
Ø 300 - 350 - 400

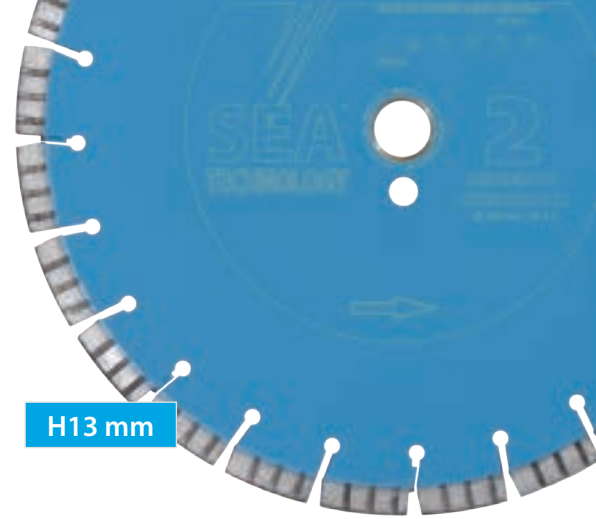

# CEMENTO SEI SILENT

CEMENTO SEI is the diamond blade for cutting cured and reinforced concrete in the range suitable for use on machines with power over 13 HP, excellent on machines with power over 20 HP. Each blade in the CEMENT range has a segment design and colour that make them immediately distinguishable from the others, facilitating the work of customers, especially renters.

AVAILABLE  
Ø 500 - 600  
650 - 700

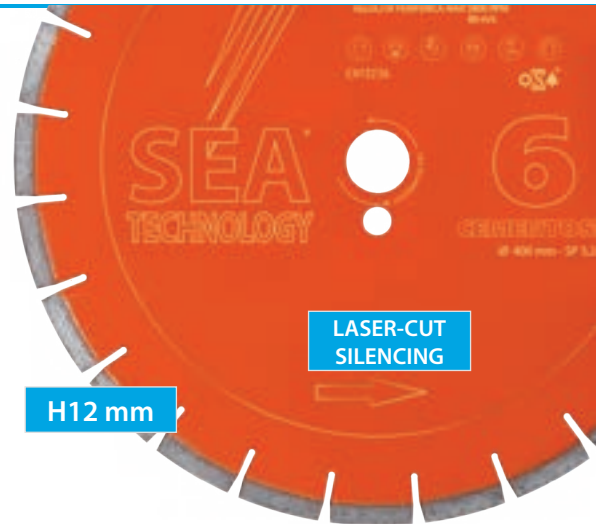

# CEMENTO CINQUE SILENT

CEMENTO CINQUE is the diamond blade for cutting cured and reinforced concrete in the range suitable for use on machines with power over 13 HP, excellent on machines with power over 20 HP. Each blade in the CEMENT range has a segment design and colour that make them immediately distinguishable from the others, facilitating the work of customers, especially renters.

AVAILABLE  
Ø 300 - 350 - 400  
450 - 500 - 600  
650 - 700 - 750

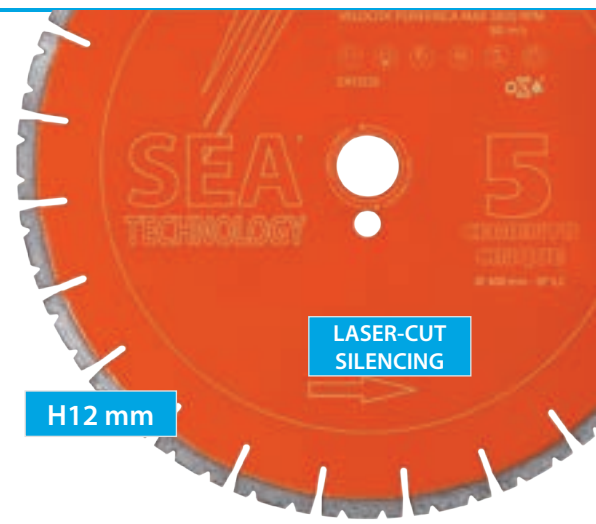

# CEMENTO QUATTRO SILENT

CEMENTO QUATTRO is the diamond blade for cutting cured and reinforced concrete in the range suitable for use on machines with power over 13 HP. Each blade in the CEMENT range has a segment design and colour that make them immediately distinguishable from the others, facilitating the work of customers, especially renters.

AVAILABLE  
Ø 300 - 350 - 400  
450 - 500  
600 - 650

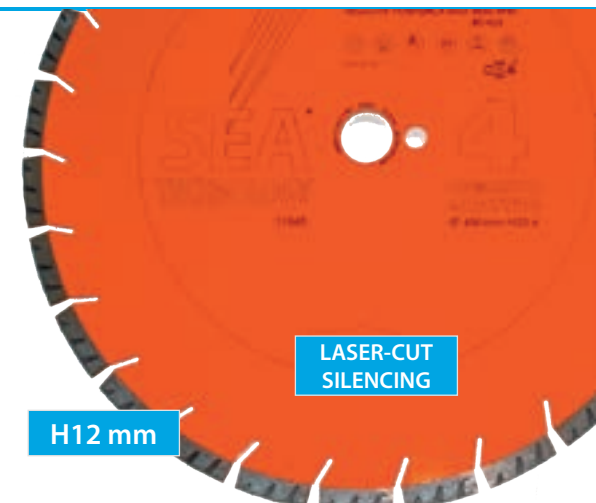

# CEMENTO TRE SILENT

CEMENTO TRE is the diamond blade for cutting cured concrete and concrete in the range suitable for use on machines with power up to 13 HP. Each blade in the CEMENT range has a segment design and colour that make them immediately distinguishable from the others, facilitating the work of customers, especially renters.

AVAILABLE  
Ø 350 - 400  
450 - 500 - 600

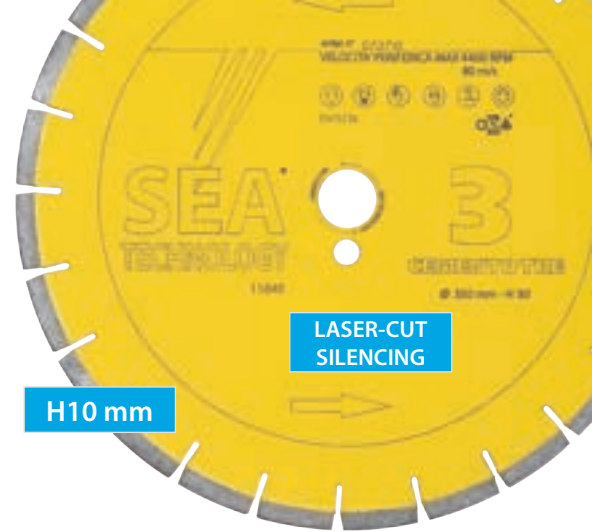

# CEMENTO DUE SILENT

CEMENTO DUE is the diamond blade for cutting cured concrete and concrete in the range suitable for use on machines with power up to 13 HP. Each blade in the CEMENT range has a segment design and colour that make them immediately distinguishable from the others, facilitating the work of customers, especially renters.

AVAILABLE  
Ø 350 - 400 450  
500 - 600

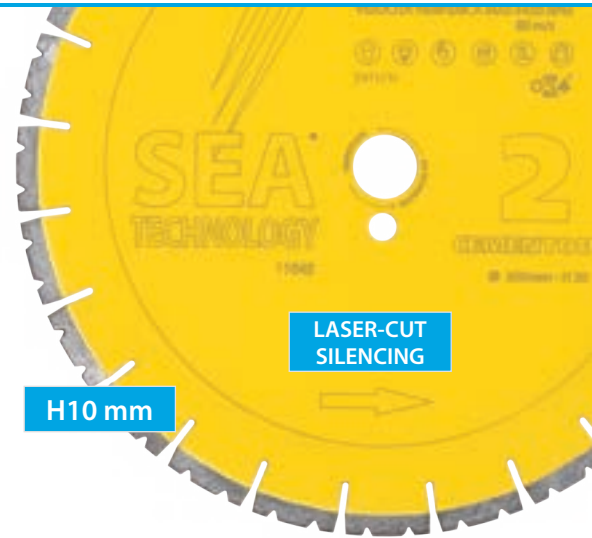

# CEMENTO UNO SILENT

CEMENTO UNO is the diamond blade for cutting cured concrete and concrete from the ideal range for power cut-off saws or small floor cutters. Each blade in the CEMENT range has a segment design and colour that make them immediately distinguishable from the others, facilitating the work of customers, especially renters.

AVAILABLE  
Ø 300 - 350  
400 - 450 - 500

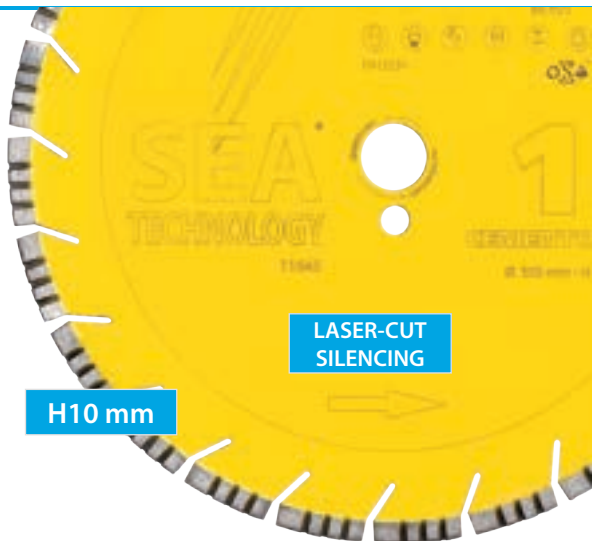

# CEMAS

This blade is ideal for those who rental floor cutting machines. The special composition of the diamond segment makes it possible to cut reinforced concrete and asphalt with the same tool, thus getting rid of the need to use two different blades. Note: both the reticulated design of the segment, which makes it particularly fast on reinforced concrete, and the H 12 mm protection tooth, which allows the tool to wear evenly on asphalt.

AVAILABLE  
Ø 300 - 350 - 400  
450 - 500 - 600

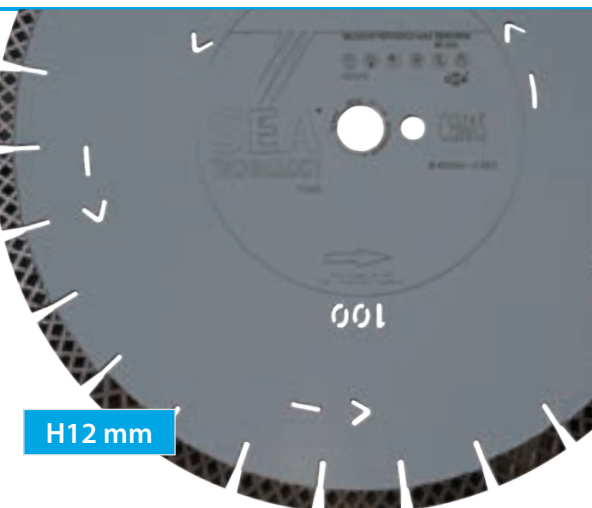

# ASFALTO CINQUE SILENT

The ASFALTO CINQUE is the silenced diamond blade in the range for use on machines with power over 13 HP, ideal for machines with power over 20 HP. The protection of the steel core of the blade, which is notoriously the weak point of asphalt blades, is made of oversized trapezoidal segments. The distinction between trapezoidal, slanted or racker protection segment is not so much qualitative as intentional to give a strong characterisation to the product, making it easier to recognise when used.

AVAILABLE  
Ø 350 - 400 - 450  
500 - 600 - 700  
800 - 900 - 1000



H12 mm

# ASFALTO QUATTRO SILENT

ASFALTO QUATTRO is the silenced diamond blade in the range suitable for use on machines with a power output of more than 13 HP. All our asphalt blades have been designed with long and wide slots, this to improve the unloading of loose materials, the penetration speed and cooling. The protection of the steel core of the blade is realised with inclined segments.

AVAILABLE  
Ø 350 - 400 - 450  
500 - 600



H12 mm

# ASFALTO TRE SILENT

ASFALTO TRE is the silenced diamond blade in the range suitable for use on machines with power ratings up to 13 HP. All our asphalt blades have been designed with long and wide slots, this to improve the unloading of loose materials, the penetration speed and cooling. The steel core of the blade is protected with vertical rackers.

AVAILABLE  
Ø 230 - 300 - 350  
400 - 450  
500 - 600



H10 mm

# ASFALTO UNO SILENT

ASFALTO UNO is the silenced diamond blade in the range suitable for use on machines with power ratings up to 13 HP. All our asphalt blades have been designed with long and wide slots, this to improve the unloading of loose materials, the penetration speed and cooling. The steel core of the blade is protected with vertical rackers.

AVAILABLE  
Ø 300 - 350 - 400  
450 - 500



H10 mm

# UNIVERSAL LASER BLADES

## LASER NOVE

Top of the range among the segmented blades, in this blade the 17 mm tooth height and the 'forging' technology are the features that make it the most high-performance and complete product. In the same tool, both cutting speed and excellent tool life have been achieved, coupled with a high degree of safety even with heights of 17 mm.

### TECHNICAL DATA SHEET

reinforced concrete, granite, porphyry, natural stone, cured concrete, bricks, tiles, gravel slabs	★★★★★	SUPER
sandstone, refractory	★★★★	EXCELLENT
single-fired ceramic, porcelain stoneware, klinker	★★★	GOOD
	★★	MEDIUM
marble, double-fired ceramics	★	SUFFICIENT
		INADEQUATE

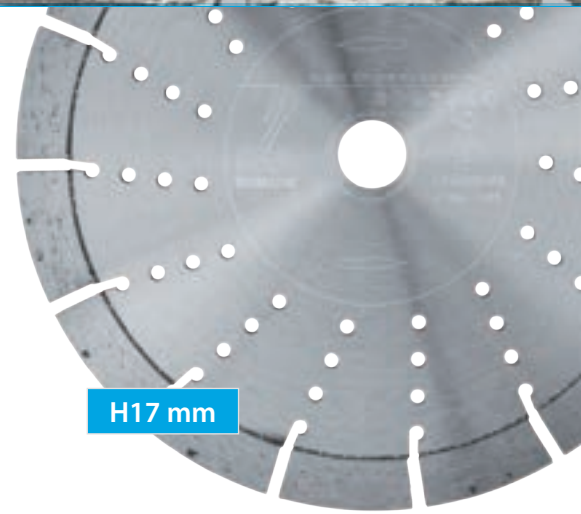

H17 mm

AVAILABLE  
Ø 230 - 300  
- 350



## LASER CINQUE

The special segment formula of this diamond blade enables the professional user to cut not only all building materials, but also materials such as iron, cast iron, sheet metal and many others, making versatility of use the main quality of this product. Excellent performance is ensured by the 8 mm height of the diamond segments.

### TECHNICAL DATA SHEET

reinforced concrete, granite, porphyry, natural stone	★★★★★	SUPER
cured concrete, bricks, tiles, sandstone, gravel slabs	★★★★	EXCELLENT
refractory, iron, cast iron	★★★	GOOD
rails, girders, profiles, float. floors	★★	MEDIUM
porcelain stoneware, klinker, single-fired, marble, wood (less than 2 cm)	★	SUFFICIENT
double-fired, fresh concrete, asphalt, aluminium, plastic, glass, steel, wood (more than 2 cm)		INADEQUATE

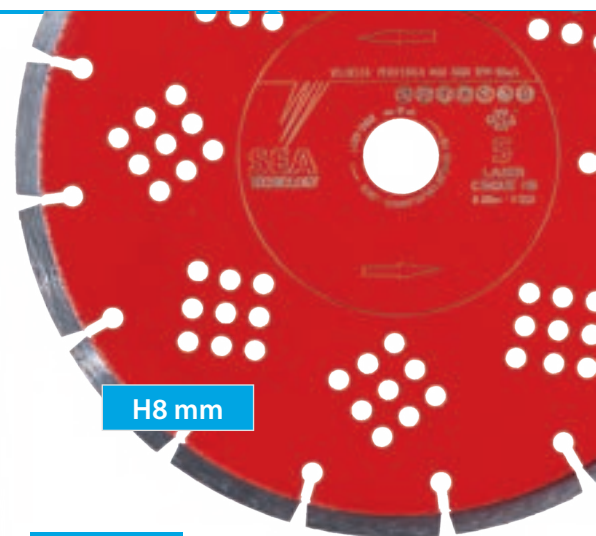

H8 mm

AVAILABLE  
Ø 115 - 230  
300 - 350  
400

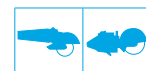

# LASER QUATTRO SILENT

The LASER QUATTRO SILENT is a premium blade aimed at satisfying the cutting needs of both a demanding, but cost-conscious public and those who expect the blade to be quieter and reduce noise by around 30%. The special CORRUGATED segment facilitates the start of cutting and segment dressing. This tool has proved very popular on sawing machines and benchtop cutters.

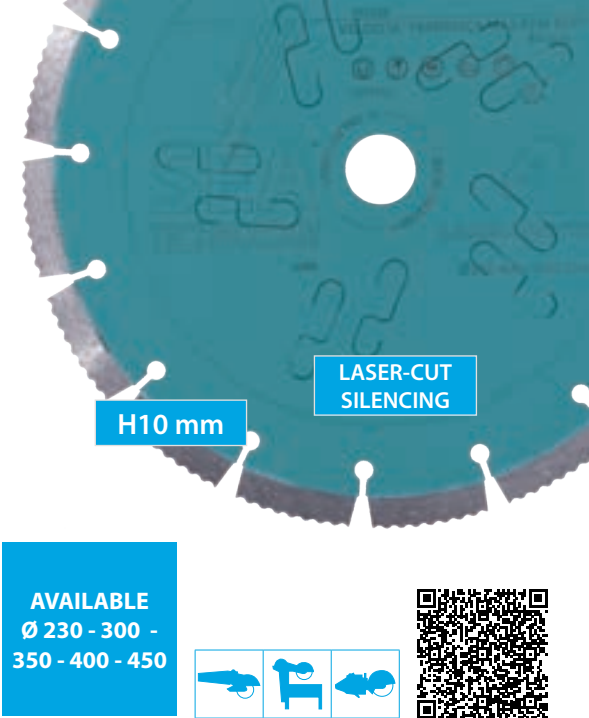

TECHNICAL DATA SHEET	
reinforced concrete, granite, porphyry, natural stone	SUPER
cured concrete, bricks, tiles, sandstone, gravel slabs, single-fired	EXCELLENT
marble, refractory, double-fired, porcelain stoneware	GOOD
	MEDIUM
	SUFFICIENT
fresh concrete, asphalt	INADEQUATE

AVAILABLE  
Ø 230 - 300 -  
350 - 400 - 450



# LASER QUATTRO

The characteristics of this blade are the same as those of the LASER QUATTRO SILENT. The core of the silenced body is not present. This blade has proved very popular on sawing machines and benchtop cutters and is available in all diameters up to 450 mm.

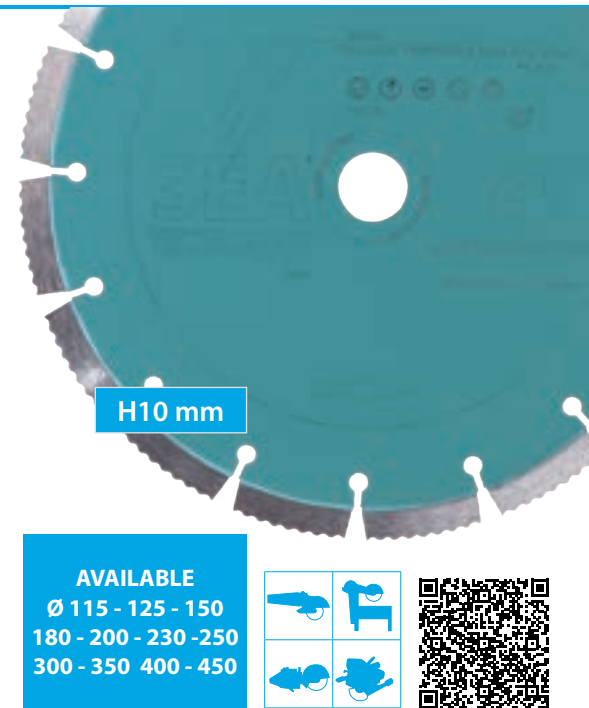

TECHNICAL DATA SHEET	
reinforced concrete, granite, porphyry, natural stone	SUPER
cured concrete, bricks, tiles, sandstone, gravel slabs, single-fired	EXCELLENT
	GOOD
	MEDIUM
	SUFFICIENT
fresh concrete, asphalt	INADEQUATE

AVAILABLE  
Ø 115 - 125 - 150  
180 - 200 - 230 - 250  
300 - 350 400 - 450

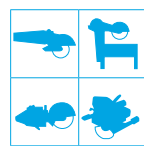

# LASER TRE

A blade with a traditional design, it is ideal for professional users looking for a reliable product at an attractive price. Laser-welded with 10-mm-high segments, starting at 230 mm diameter, it allows for excellent output.



TECHNICAL DATA SHEET	
	SUPER
reinforced concrete, cured concrete, bricks, tiles	EXCELLENT
granite, natural stone, porphyry	GOOD
refractory, sandstone, gravel slabs	MEDIUM
single-fired, double-fired, porcelain stoneware, klinker	SUFFICIENT
marble, fresh concrete, asphalt	INADEQUATE

AVAILABLE  
Ø 115 - 125 - 230  
300 - 350 - 400



# LASER DUE

The characteristics of this diamond blade are the same as the LASER TRE but with higher speed and lower yield. Ideal for professional users looking for good cutting capacity at an attractive purchase price.



H10 mm

TECHNICAL DATA SHEET	
	★★★★★
reinforced concrete, cured concrete, bricks, tiles	★★★★
granite, natural stone, porphyry	★★★
refractory, sandstone, gravel slabs	★★
single-fired, double-fired, porcelain stoneware, klinker	
marble, fresh concrete, asphalt	

AVAILABLE  
 Ø 115 - 125 -  
 150 180 - 230  
 - 300  
 350 - 400

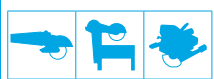

# CANTIERE TRE SILENT

Silenced universal blade for water-cooled construction site cutters. The segment's traditional design and laser welding make it a highly reliable product. The excellent performance is ensured by the height of the segments of 10 mm.

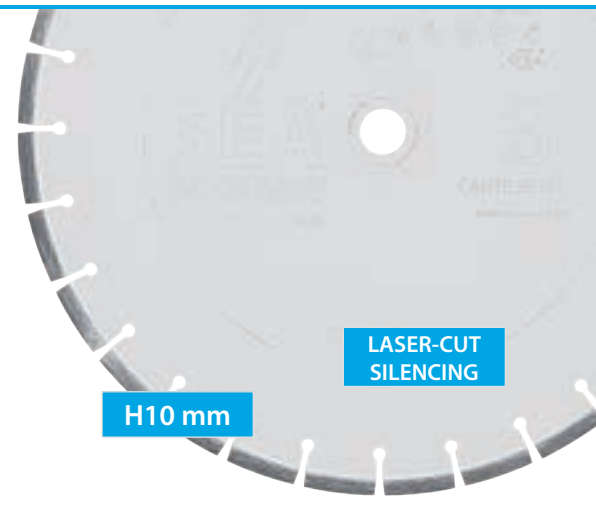

LASER-CUT  
 SILENCING

H10 mm

TECHNICAL DATA SHEET	
	★★★★★ SUPER
reinforced concrete, cured concrete, bricks, tiles	★★★★ EXCELLENT
granite, porphyry, natural stone, refractory	★★★ GOOD
sandstone, gravel slabs	★★ MEDIUM
single-fired, double-fired, porcelain stoneware, klinker	★ SUFFICIENT
marble, fresh concrete, asphalt	INADEQUATE

AVAILABLE  
 Ø 300 - 350 - 400  
 450 - 500 - 550 - 600  
 625 - 650 - 700 - 725  
 750 - 800 - 900 - 1000



# LASER SCAN QUATTRO

Electric grooving blade. The special formulation of the diamond segment makes it particularly durable and effective in heavy-duty applications such as grooving. Available in all diameters up to 230 mm.

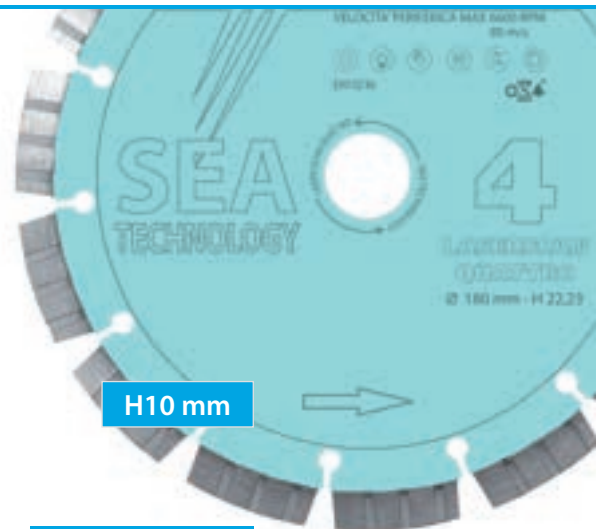

H10 mm

TECHNICAL DATA SHEET	
cured concrete	★★★★★ SUPER
reinforced concrete, granite, natural stone, porphyry, refractory	★★★★ EXCELLENT
sandstone, gravel slabs	★★★ GOOD
single-fired, porcelain stoneware, klinker	★★ MEDIUM
double-fired	★ SUFFICIENT
marble, fresh concrete, asphalt	INADEQUATE

AVAILABLE  
 Ø 125 - 140 - 150  
 160 - 180  
 190 - 230









# UNIVERSAL TURBO BLADES

## TURBO SEI

The TURBO SEI is also a blade that ranks among the top of the range of universal turbo blades. It is distinguished from others by its speed and cutting precision, due to the special design of the diamond crown. Under the name TURBO JET this blade has been in our catalogue continuously since 1987, confirming the quality of the project.

### TECHNICAL DATA SHEET

concrete, granite, porphyry, natural stone		<b>SUPER</b>
cured concrete, bricks, tiles, sandstone, gravel slabs, single-fired		<b>EXCELLENT</b>
marble, refractory, double-fired, porcelain stoneware, klinker		<b>GOOD</b>
		<b>MEDIUM</b>
		<b>SUFFICIENT</b>
fresh concrete, asphalt		<b>INADEQUATE</b>



H8 mm



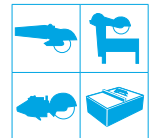

AVAILABLE /  
Ø 115 - 125 - 150  
180 - 230 - 250  
300 - 350



## TURBO QUATTRO

The TURBO QUATTRO is a blade that has always been known for its good cutting capacity and durability on granite and natural stone. The patented diamond core bit design, with its shape, allows double cooling and dust bladecharge compared to conventional core bits, thus improving both penetration speed and yield. Under the name CONVEX this blade has been in our catalogue continuously since 1987, confirming the quality of the project.

### TECHNICAL DATA SHEET

granite, porphyry, natural stone		<b>SUPER</b>
reinforced concrete, cured concrete, bricks, tiles		<b>EXCELLENT</b>
refractory, sandstone, gravel slabs, porcelain stoneware, klinker		<b>GOOD</b>
marble, single-fired		<b>MEDIUM</b>
double-fired		<b>SUFFICIENT</b>
fresh concrete, asphalt		<b>INADEQUATE</b>

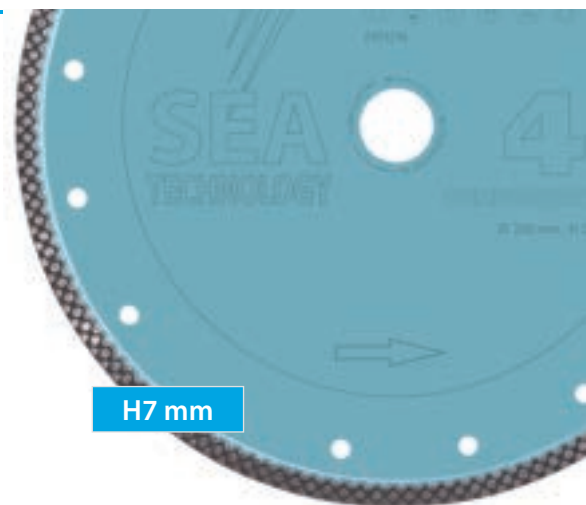

H7 mm

AVAILABLE  
Ø 115 - 125 - 150  
180 - 200 - 230



# TURBO TRE

The TURBO TRE is a blade designed for professional users looking for a reliable product at an attractive price. It was conceived with the aim of cutting all building materials efficiently, making versatility and value for money its best asset.

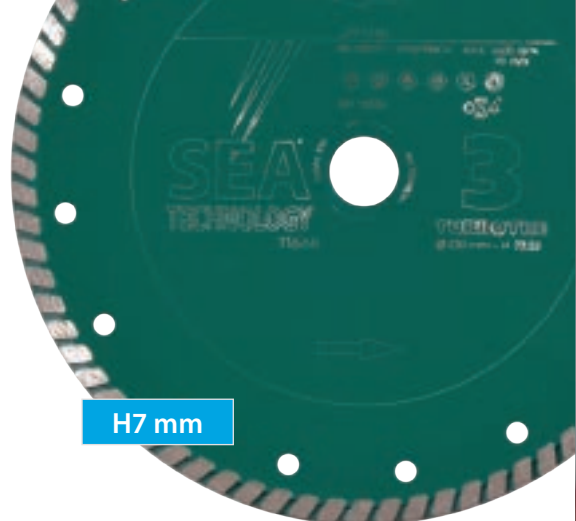

H7 mm

TECHNICAL DATA SHEET	
	★★★★ SUPER
cured concrete, bricks, tiles	★★★★ EXCELLENT
granite, natural stone, porphyry, reinforced concrete	★★★ GOOD
marble, refractory, sandstone, gravel slabs, double-fired, single-fired	★★ MEDIUM
porcelain stoneware, klinker	★ SUFFICIENT
fresh concrete, asphalt	INADEQUATE

AVAILABLE  
Ø 115 - 230



# TURBO DUE

This blade has been designed and manufactured to meet the needs of those users who make occasional use of the diamond blade. Suitable for both professional and home users, it has an excellent price/performance ratio and guarantees good performance both in terms of cutting speed and durability.



H7 mm

TECHNICAL DATA SHEET	
	★★★★ SUPER
	★★★★ EXCELLENT
cured concrete, bricks, tiles	★★★ GOOD
reinforced concrete, granite, porphyry, natural stone, sandstone, gravel slabs, double-fired	★★ MEDIUM
marble, refractory, single-fired, porcelain stoneware, klinker	★ SUFFICIENT
fresh concrete, asphalt	INADEQUATE

AVAILABLE  
Ø 115 - 230







# BLADES FOR CERAMIC

## CER SETTE TURBO

The CER SETTE TURBO blade, the latest addition to the porcelain tile cutting product range, is distinguished from other blades on the market by its remarkable performance. Developed for cutting the latest generation of stoneware fired at very high temperatures, it is able to guarantee a 30% higher execution speed compared to the CER CINQUE TURBO, one of the highest performing blades on the market, and ensures a 50% higher yield thanks to the 10 mm height of the diamond.

### TECHNICAL DATA SHEET

marble, double-fired, single-fired, porcelain stoneware, klinker		<b>SUPER</b>
granite, natural stone, porphyry		<b>EXCELLENT</b>
		<b>GOOD</b>
		<b>MEDIUM</b>
		<b>SUFFICIENT</b>
cured concrete, bricks, tiles, concrete, refractory, sandstone, gravel slabs, fresh concrete, asphalt		<b>INADEQUATE</b>

**THICKNESS**  
1.2 mm





**AVAILABLE**  
Ø 115 - 125 - 230  
with or without  
reinforcement



## CER CINQUE TURBO

The best available on the market for cutting all ceramic materials, from the hardest and most brittle to the most friable. It makes sharpness and cutting precision its best weapons, thanks also to the very low crown thickness of 1.3 mm. Available in all diameters up to 400 mm.

### TECHNICAL DATA SHEET

marble, double-fired, single-fired, porcelain stoneware, klinker		<b>SUPER</b>
granite, natural stone, porphyry		<b>EXCELLENT</b>
		<b>GOOD</b>
		<b>MEDIUM</b>
		<b>SUFFICIENT</b>
cured concrete, bricks, tiles, concrete, refractory, sandstone, gravel slabs, fresh concrete, asphalt		<b>INADEQUATE</b>

**THICKNESS**  
1.3 mm





**AVAILABLE**  
Ø 85 - 115 - 125 150  
- 180 - 200 - 230 250 -  
300 - 350 - 400



# CER CINQUE LASER

The same features as the CER CINQUE TURBO with a different crown design. In use, almost imperceptible difference in cutting precision (more) and penetration speed (less) compared to the CER CINQUE TURBO. The CER CINQUE LASER also has a thickness of 1.2 mm, but a slightly less comprehensive range of diameters.

## TECHNICAL DATA SHEET

marble, double-fired, single-fired, porcelain stoneware, klinker		<b>SUPER</b>
granite, natural stone, porphyry		<b>EXCELLENT</b>
		<b>GOOD</b>
		<b>MEDIUM</b>
		<b>SUFFICIENT</b>
cured concrete, bricks, tiles, concrete, refractory, sandstone, gravel slabs, fresh concrete, asphalt		<b>INADEQUATE</b>

**THICKNESS**  
1.3 mm

**AVAILABLE**  
Ø 115 - 150 - 180  
200 - 230 - 250  
300 - 350 - 400

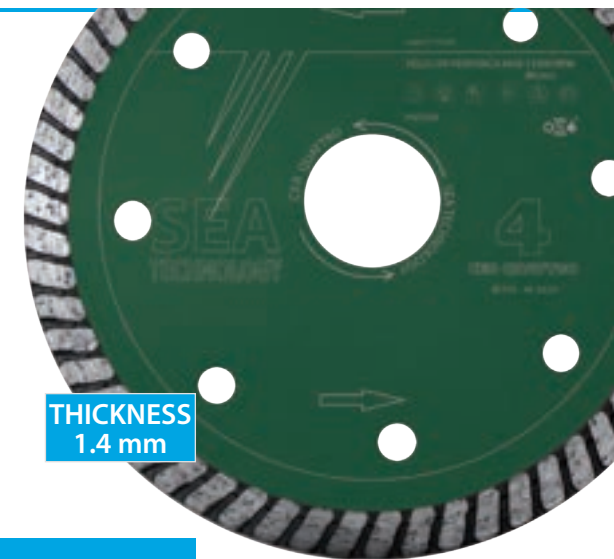

**THICKNESS**  
1.4 mm





**AVAILABLE**  
Ø 115 - 125



# CER QUATTRO

The CER QUATTRO is a diamond blade ideal for non-intensive use on porcelain stoneware. For those who are cost-conscious but do not want to compromise on quality, it offers excellent value for money. All the reliability and performance of SEA Technology at favourable conditions. N.B: do not use for jolly cutting.

## TECHNICAL DATA SHEET

		<b>SUPER</b>
marble, double-fired, single-fired, porcelain stoneware, klinker		<b>EXCELLENT</b>
granite, natural stone, porphyry		<b>GOOD</b>
		<b>MEDIUM</b>
		<b>SUFFICIENT</b>
		<b>INADEQUATE</b>

# CER TRE

The top of the range until the advent of the super-thin CER CINQUE TURBO AND LASER, it is an excellent blade on all ceramic and porcelain tiles and is available in all diameters up to 350 mm.

## TECHNICAL DATA SHEET

		<b>SUPER</b>
marble, double-fired, single-fired		<b>EXCELLENT</b>
porcelain stoneware, klinker		<b>GOOD</b>
granite, natural stone, porphyry		<b>MEDIUM</b>
		<b>SUFFICIENT</b>
cured concrete, bricks, tiles, concrete, refractory, sandstone, gravel slabs, fresh concrete, asphalt		<b>INADEQUATE</b>

**THICKNESS**  
1.6 mm

**AVAILABLE**  
Ø 115 - 125 - 150  
180 - 200 - 230  
250 - 300 - 350



# CER DUE

The CER DUE is the blade for users who do not need to cut harder ceramics, but only medium and low hardness ceramics. Available in all diameters up to 350 mm.



**THICKNESS**  
1.6 mm

TECHNICAL DATA SHEET	
	★★★★ SUPER
double-fired	★★★★ EXCELLENT
marble, single-fired	★★★ GOOD
	★★ MEDIUM
granite, natural stone, porphyry, stoneware, klinker	★ SUFFICIENT
cured concrete, bricks, tiles, concrete, refractory, sandstone, gravel slabs, fresh concrete, asphalt	INADEQUATE

**AVAILABLE**  
Ø 115 - 125 - 150  
180 - 200 - 230  
250 - 300 - 350



# BLADES FOR STONE AND SPECIALS

## PORFIDO SEI SILENT

Porphyry cutting blade for cutting porphyry with water or power cutters. Developed in porphyry quarrying areas and perfected in the best stone processing sites. Available in diameters from 300 mm to 400 mm.

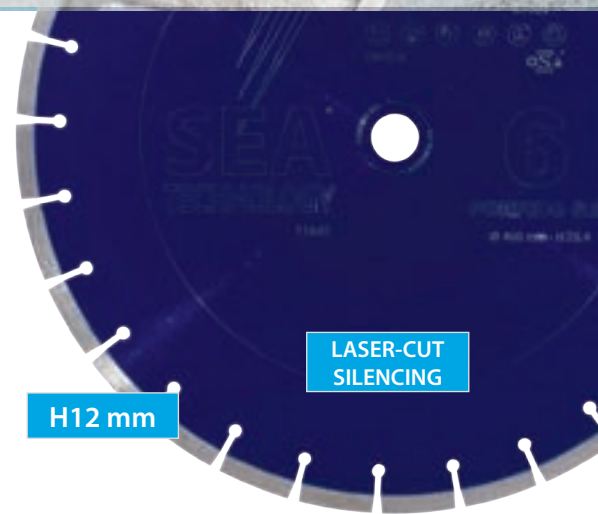

AVAILABLE  
Ø 300 - 350 - 400



## GRANITO CINQUE SILENT

Saw blade for cutting granite with water- or power cutters. Good cutting speed, adequate durability, ideal precision and low noise make it the ideal blade for granite layers. Available in diameters from 250 mm to 625 mm.

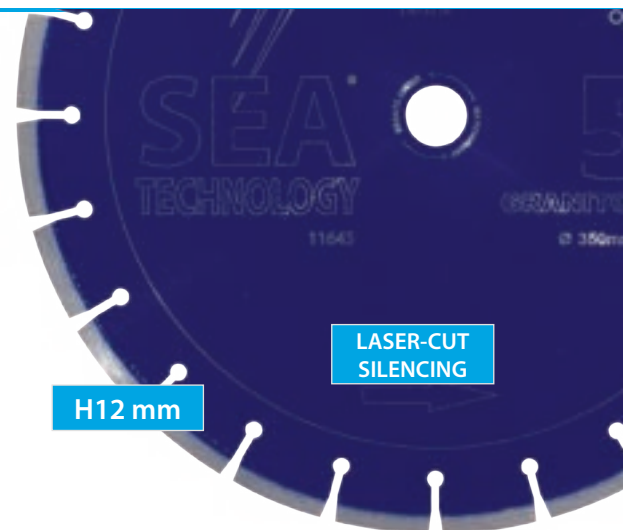

AVAILABLE  
Ø 250 - 300 - 350  
400 - 450 - 500  
600 - 625



# REFRATTARI CINQUE

Refractory cutting blade with water-cooled construction cutters. Fireplaces, stoves, ovens, and all those applications where refractory stones need to be cut, laid and adapted to the most complicated spaces. Accurate and fast. Available in diameters from 300 mm to 500 mm.



H10 mm

AVAILABLE  
Ø 300 - 350 - 400  
450 - 500



# ELETTRO TRE

Diamond blade ideal for dry cutting of all types of marble with electric grinders. In this model, the diamond powder is not mixed with other metal binders, but is fixed directly onto the steel body of the blade by a process known as 'electroplating'.

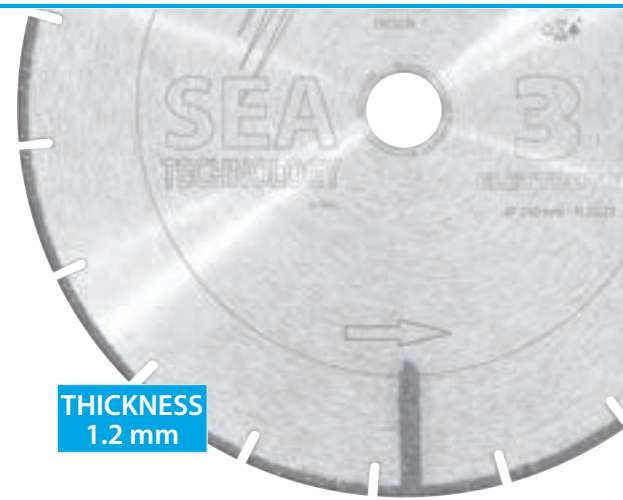

THICKNESS  
1.2 mm

AVAILABLE  
Ø 115 - 125  
180 - 230



# MARMO QUATTRO SILENT

Saw blade for cutting marble with water-cooled construction cutters. Available in diameters from 250 mm to 625 mm.

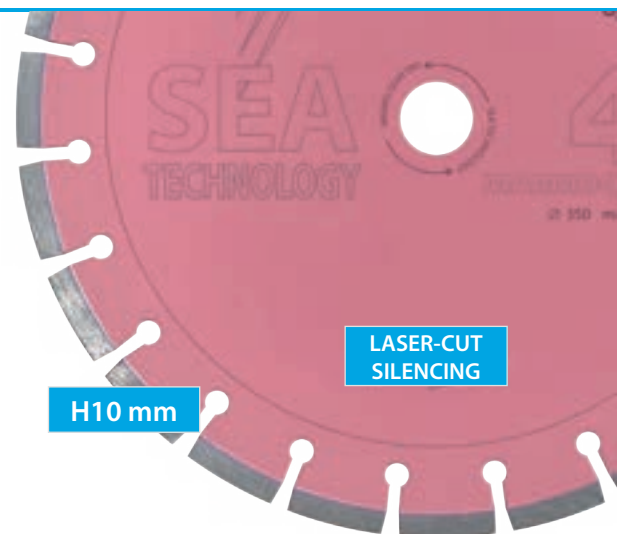

LASER-CUT  
SILENCING

H10 mm

AVAILABLE  
Ø 250 - 300 - 350  
400 - 450 - 500  
600 - 625



# METALLO CINQUE

The new generation of diamond blades for iron is a definitive replacement for the abrasive blade, providing better performance at a lower price. The special production technique and the high quality of the raw materials used mean that METALLO CINQUE can last up to 60/80 times longer than a normal iron abrasive blade, is safer and also environmentally friendly. Costs far less than normal abrasive blades, also due to the high cutting speed resulting from the ultra-thin thickness. It retains its diameter until the end of its useful life.

## TECHNICAL DATA SHEET

soft steel, steel with low % carbon, round and square tubes, angle iron, rails, nodular cast iron, heavy alloys	★★★★★	<b>SUPER</b>
steel with high % of carbon	★★★★	<b>EXCELLENT</b>
stainless steel	★★★	<b>GOOD</b>
copper pipes	★★	<b>MEDIUM</b>
	★	<b>SUFFICIENT</b>
		<b>INADEQUATE</b>



AVAILABLE  
Ø 115 - 125 - 230



# EMERGENZA CINQUE

As its name implies, EMERGENZA CINQUE is the blade for emergencies: it dry cuts all types of material with very high speed, but has a relatively short life. Mounted on internal combustion engine driven power cutters, it proves its extreme efficiency and cutting speed, thanks to the special production technique whereby the diamond is fixed directly on the surface of the steel core. Not suitable for general construction use.

## TECHNICAL DATA SHEET

	★★★★★	<b>SUPER</b>
	★★★★	<b>EXCELLENT</b>
	★★★	<b>GOOD</b>
cement, bricks, tiles, reinforced concrete, granite, natural stone, porphyry, marble, refractory, double/single-fired ceramics, plastic, pvc, plexiglass, porcelain stoneware, klinker, steel, iron, sheet metal, wood	★★	<b>MEDIUM</b>
fresh concrete, asphalt	★	<b>SUFFICIENT</b>
sandstone, washed gravel slabs		<b>INADEQUATE</b>

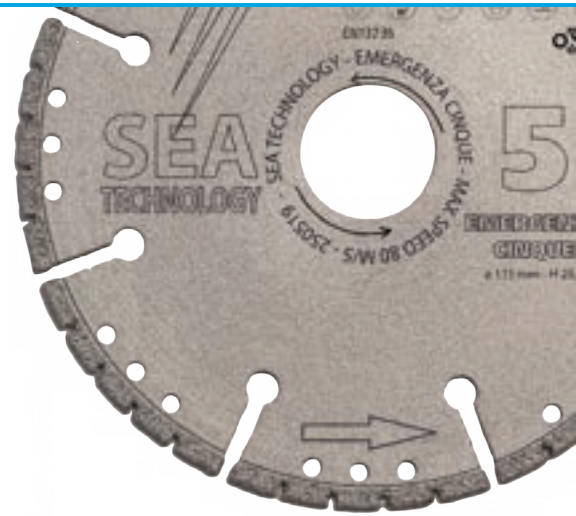

AVAILABLE  
Ø 115 - 230  
300 - 350



# MULTICUT QUATTRO

The MULTICUT QUATTRO diamond blade has a special coating with industrial diamond flakes directly on the crown using 'VACUUM' technology. It can definitively be the true universal diamond blade, as it allows cutting a multitude of different materials and also largely replaces the abrasive blade. Just mount a single blade on the grinder and cut everything. Does not release dust during cutting, as is the case with abrasive blades and this makes it even more useful and versatile.

## TECHNICAL DATA SHEET

	★★★★★	<b>SUPER</b>
	★★★★	<b>EXCELLENT</b>
	★★★	<b>GOOD</b>
cement, bricks, tiles, reinforced concrete, granite, natural stone, porphyry, marble, refractory, double/single-fired ceramics, plastic, pvc, plexiglass, porcelain stoneware, klinker, steel, iron, sheet metal, wood	★★	<b>MEDIUM</b>
fresh concrete, asphalt	★	<b>SUFFICIENT</b>
sandstone, washed gravel slabs		<b>INADEQUATE</b>



AVAILABLE  
Ø 115 - 125





# CUTTING CONSTRUCTION MACHINERY

## SEATWIN 180

The SEATWIN 180 allows grooves of up to 6 cm in depth and width to be made effortlessly, thanks to the power of its motor and the excellent ergonomics of its handle. It also allows work to be carried out with total dust abatement thanks to its dust extractor and tilting crankcase. It comes in a handy metal box and equipped with a pair of LASER SCAN QUATTRO blades.



### TECHNICAL DATA SHEET

🔧 Power input: 1800 W - 230 V	🔧 Cutting depth: 30 to 60 mm
🔧 Blade diam: 180 mm - Hole: 22.2 mm	🔧 Set-up for vacuum cleaners
🔧 Idle Rpm: 4900/min	🔧 Supplied with diamond blades and metal box
🔧 Cutting width: 20 to 60 mm	🔧 Weight 6 kg



## SEATABLE 200 PONTE

The SEATABLE 200 Ponte is a machine designed for professionals. Designed to be agile and precise, it satisfies installers who seek quality at the right price and with a fine finish. The machine comes standard with Cer Cinque Turbo or Laser blades, the top-of-the-range ceramic blades in the line.



### TECHNICAL DATA SHEET

🔧 Available with 230 V - 1.1 kW - 1.5 hp motor	🔧 45° Tilting Head
🔧 180 or 200 mm Diamond Blade Hole 25.4 mm	🔧 Sliding Head on 4 Stainless Steel Bearings
🔧 Cutting height in one Pass Max. 50 mm	🔧 Dimensions (Lx WxH): 150 x 55 x 80 cm
🔧 Max. Cutting Length 750 mm	🔧 Weight: 50 Kg



# SEATABLE 400 PONTE

The SEATABLE 400 Ponte is a multi-purpose machine: suitable for cutting both ceramics and bricks, or brick materials in general. The cutting length is 135 cm and the maximum cutting height is 20 cm. The six bearings ensure constant and long-lasting precision. The machine is supplied with a Cantiere Tre blade produced using the 'Detenso' technique.



## TECHNICAL DATA SHEET

Available with 230 V - 2.2 kW motor	45° Tilting Head
400 mm Diamond Blade Hole 25.4 mm	Double Rail Sliding Head on 6 Bearings
Cutting height in 1 Pass Max. 140 mm 204 mm in 2 Passes	Dimensions (Lx WxH): 170 x 56 x 145 cm
Max. Cutting Length 1350 mm	Weight: 115 Kg

# SEATABLE 400

SEATABLE 400 offers top-class performance with contained weight and dimensions. For professional users who need the ability to cut materials up to 20 cm high, in addition to the performance provided by the 45° angled cut. The machine is equipped with triple spring for head lifting, ABS tank and double splash guard. The machine is supplied with a Cantiere Tre blade produced using the 'Detenso' technique.



## TECHNICAL DATA SHEET

Available with 230 V motor	45° Tilting Head
350 or 400 mm Diamond Blade Hole 25.4 mm	Welded Stainless Steel Carriage Guide
Cutting height in 1 Pass Max. 140 mm 204 mm in 2 Passes	Dimensions (Lx WxH): 140 x 66 x 90 cm
Max. cutting length 600 mm	Weight: 70 Kg

# SEATABLE 401

SEATABLE 401 offers top-class performance with contained weight and dimensions. For professional users who need the ability to cut materials up to 20 cm high, in addition to the performance provided by the 45° angled cut. The machine is equipped with triple spring for head lifting, ABS tank and double splash guard. The machine is supplied with a Cantiere Tre blade produced using the 'Detenso' technique.



## TECHNICAL DATA SHEET

Available with 230 V motor	45° Tilting Head
350 or 400 mm Diamond Blade Hole 25.4 mm	Welded Stainless Steel Carriage Guide
Cutting height in 1 Pass Max. 140 mm 240 mm in 2 Passes	Dimensions (Lx WxH): 114 x 62 x 123 cm
Max. cutting length 600 mm	Weight: 73 Kg

# SEATABLE 700

Like the previous model, SeaTable 700 was developed to solve the problem of block cutting in modern construction sites. It delivers top-class performance with low weight and dimensions. The cutting height is 29 cm in single pass and 42 cm in double pass, three-phase 5.5 hp motor. The machine is supplied with a Cantiere Tre blade produced using the 'Detenso' technique.



## TECHNICAL DATA SHEET

Available at 400 V - Hp 5.5 - 4.0 kW	Max. Cutting Length 700 mm
Blades diam. 700 mm - Hole 60 mm	Tilting Head 15°, 30° and 45°
Adjustable Carriage Guides	Dimensions (LxWxH) 185 x 85 x 164 mm
Max. cutting height 295 mm in 1 pass 420 mm in 2 Passes	Weight: 120 Kg

# SEATABLE 701

SEATABLE 701 is a professional saw for cutting stone and masonry with professional cutting technology for large materials and requires little maintenance; it guarantees reliability over time; sturdy bench with 300 kg capacity, galvanised with engraved scale; protective handle for operator's safety; safe support on three points, of which the front articulated wheel designed to guarantee better levelling on building sites; stable and resistant frame high-strength, low-wear steel bench profile and bearings; low tool consumption due to precise bench guidance; SEA Technology water supply system ensures perfect blade cooling and immediate scrap removal; easy removal of water pump; water tank removable from rear; direct drive (flat motor) - no V-belts - no wear and tear - direct power transmission.



## TECHNICAL DATA SHEET

Max. blade Ø: 700 mm	Energy consumption: 11 A Power supply: manual
Max. cutting depth: 270 mm	Table width: 630 mm
Max. cutting length: 520 mm	Saw blade speed: 1400 <sup>1</sup> /min
Hole Blade: 60 mm + PIN	Dimensions (LxWxH) 152 x 94 x 143 mm
Motor power Hp 7.4 - 5.5 kW - 400 V	Protection: IP 55 - Weight: 230 Kg

Equipped with hour meter

# SEATABLE 1001

The market evolves and the product offering also follows the new requirements. Increasingly popular large block constructions require the use of machines with adequate cutting capacity. Hence the birth of the SeaTable1001: 42 cm cutting height in single pass and 60 cm in double pass, three-phase motor for an easy and immediate approach to the many needs of the site. The cutting head is clamped by means of a lever and an interlocking selector switch; the water tank is fully removable for quick cleaning; the handles for moving the carriage are away from the cutting unit.



## TECHNICAL DATA SHEET











Available at 400 V - Hp10 - 7.5 kW	Cutting length 660 mm - Bench 745 mm
Blades diam. 1000 mm - Hole 60 mm	Fixed Head - Protection Class IP54
Blade speed 910 / min.	Dimensions (LxWxH) 180 x 105 x 150 mm
Cutting Height Standard 370 mm Max 420 mm	Weight: 352 Kg

# SEABAND 500

SEABAND 500 is a band saw particularly suitable for cellular concrete and various brick bricks with a maximum density of ROH1. Due to their size, the belt pulleys guarantee an excellent belt life. The automatic belt tensioning device ensures constant and optimal belt tensioning and excellent cutting precision, also reducing the risk of belt breakage. The quick-closing device of the cutting table allows the table to be opened in a single operation and the belt to be changed in no time. SEABAND 500 's automatic switch-off prevents unnecessary overloading of the band, which only remains in operation when is actually cutting. SEABAND 500 is equipped with an hour counter.



## TECHNICAL DATA SHEET

 Cutting height/length: 510/700 mm	 Maximum bench capacity: 50 kg
 Belt length: 3750 mm	 Bench size: 920/710 mm
 Power: 1.1 kW / 400 V 1.5 kW/230 V	 Left-hand band saw support clearance: 490 mm
 Energy consumption: 2.7 A / 12.5 A	 Dimensions (W x D x H): 1080 x 750 x 1840 mm
 Ø Band saw pulley: 502 mm	 Weight: 173 Kg



Automatic tensioning device



Large pulleys



Inclined cut on bricks with empty cavities

## MAXIMUM DENSITY ROH1

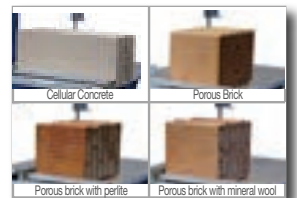

Some examples of materials that Seaband 500 can cut





## THERMAL MATERIALS

# SEACUT 350 SPECIAL

The SEACUT 350 SPECIAL petrol-powered two-stroke motor uses the EasyLube system to electronically add oil to the fuel, eliminating mixing errors and their consequences. The ignition is simple, with electronic injection and no valves to pull manually. A 5.5 HP motor carrying a 350 mm blade with 9500 RPM for cutting concrete, reinforced concrete, asphalt, stone and other building materials in general.



### TECHNICAL DATA SHEET

 Single-cylinder 2-stroke engine, 4-channel washing

 Oil tank capacity: 0.32 l

 Displacement: 81 cm<sup>3</sup>

 Air filter: paper/weight: 10.5 Kg

 Max. power per rev: 5.6 HP/9,300 rpm

 Cutting wheel diameter: 350 mm/14 inc

 Maximum no-load speed: 9.500 +/- 200 rpm

 Maximum cutting depth: 125 mm/5inc

 Fuel tank capacity: 0.9 l









 Dimensions (HxWxL) mm: 430 x 267 x 775



# SEAFLOOR 350

The SEAFLOOR350 provides excellent performance while being light and manoeuvrable. Thanks to its Honda GX200 engine, synonymous with reliability, it cuts up to 120 mm with extreme precision, guaranteed by the short wheelbase and the weight of the tank placed in front of the blade. Supplied with Ø 350 blade.

## TECHNICAL DATA SHEET









 Diamond blade diameter 350 mm, hole 25.4 mm	 12 Lt water tank
 Cutting depth 120 mm	 Dimensions (LxWxH) 925x548x950
 Honda GX200 engine 4.1 kW - 5.5 hp	 Weight 68 kg
 Rpm 3600 MIN <sup>-1</sup>	 According to EC standards
 Equipped with hour meter	



# SEAFLOOR 450

SEAFLOOR 450 allows a cutting depth of 170 mm. Equipped with the Honda GX 390 engine, which is synonymous with reliability, it allows work with extreme precision, given the short wheelbase and the weight of the tank, which is purposely placed above the blade.

## TECHNICAL DATA SHEET









 Diamond blade diameter 450 mm, hole 25.4 mm	 33 litre water tank
 Cutting depth 170 mm	 Dimensions (LxWxH) 112x55x106
 Honda GX390 8.7 Kw - 11.7 HP motor	 Weight 113 kg
 Rpm 3600 MIN <sup>-1</sup>	 According to EC standards
 Equipped with hour meter	



# SEAFLOOR 500

SEAFLOOR 500 is top of the range and the most suitable for the most difficult jobs. Thanks to the 500 mm blade and the Honda GX-390 engine, it can cut up to 190 mm. Excellent cutting precision and stability thanks to the short wheelbase and tank above the blade. Supplied with Ø 500 blade.

## TECHNICAL DATA SHEET

 Diamond blade diameter 500 mm, hole 25.4 mm	 Equipped with hour meter
 Cutting depth 190 mm	 33 litre water tank
 Honda GX390 engine 8.7 kW - 11.7 hp	 Dimensions (LxWxH) 118 x56x105
 Rpm 3600 MIN <sup>-1</sup>	 Weight 110 kg
 According to EC standards	

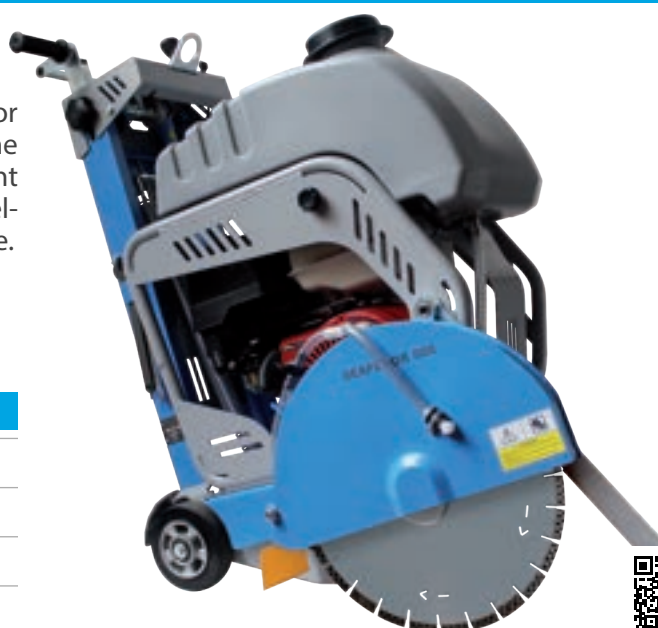









# SEAFLOOR 500 S

The new SEAFLOOR 500 S has been developed to meet the demands of those who need a powerful and reliable floor saw that is, at the same time, lighter and more manoeuvrable than existing ones.

IT IS suitable for cutting concrete and asphalt with a depth of up to 190 mm and has the same features as SEAFLOOR 500 in terms of motorisation (Honda GX-390 motor), while having a weight reduced to 105 kg. In addition, a new quick-release water tank facilitates refuelling, which can be done without having to mobilise the machine: an important configuration, which is very useful for use on road construction sites where the cutting area is often far from the refuelling tank.

## TECHNICAL DATA SHEET









 Diamond blade diameter 500 mm, hole 25.4 mm	 20 Lt water tank
 Cutting depth 190 mm	 Dimensions (LxWxH) 110x53x95
 Honda GX390 8.7 Kw - 11.7 HP motor	 Weight 105 kg
 Rpm 3600 MIN <sup>-1</sup>	 According to EC standards
 Equipped with hour meter	



# SEAFLOOR 501

SEAFLOOR 501 is a professional petrol-driven floor saw for cutting asphalt and concrete. It is equipped with a 13 HP Honda engine, which guarantees in a single pass cuts up to 20 mm thick and with a maximum depth of 180 mm, depending on the tool fitted: a diamond blade (Ø 500 mm, bore 25.4 mm), a beating wheel, and tools for making trenches for laying fibre optics. The water for cooling the diamond blade, contained in the 30-litre tank, passes directly into the flange, optimising its consumption. SEAFLOOR 501 also optimises the use of expensive backfill material for micro-trenching once it has been performed, thanks to its cut thickness of only 15-16 millimetres. The anti-vibration handle and the possibility of continuous 180° adjustment facilitate the operator's work.

## TECHNICAL DATA SHEET

 Diamond blade diameter 500 mm, hole 25.4 mm	 According to EC standards
 Cutting depth 180mm	 30 Lt water tank
 Honda GX390 8.7 Kw - 11.7 HP motor	 Dimensions (LxWxH) 1040 x 585 x 910 mm
 Rpm 2300 MIN <sup>-1</sup>	 Weight 105 kg













# SEAFLOOR 600

SEAFLOOR600 is the most suitable floor cutting machine for the demolition of old industrial floors or the cutting of micro trench for fibre optics, due to its ability to make deep and challenging cuts up to 220mm deep.

Available with manual feed (Honda/Kohler 25 HP). Ideal for machining large areas, it is equipped in both versions with automatic blade descent, hour counter and LED spotlight for lighting the cutting area.

## TECHNICAL DATA SHEET

 Diamond blade diameter 600 mm	 Equipped with hour meter
 Cutting depth 22 cm	 Manual advancement
 Automatic blade descent	 Dimensions (LxWxH) 158x76x130
 Honda/Kohler 25 HP petrol engine	 Weight 220 kg
 Rpm 3000 MIN <sup>-1</sup>	 According to EC standards

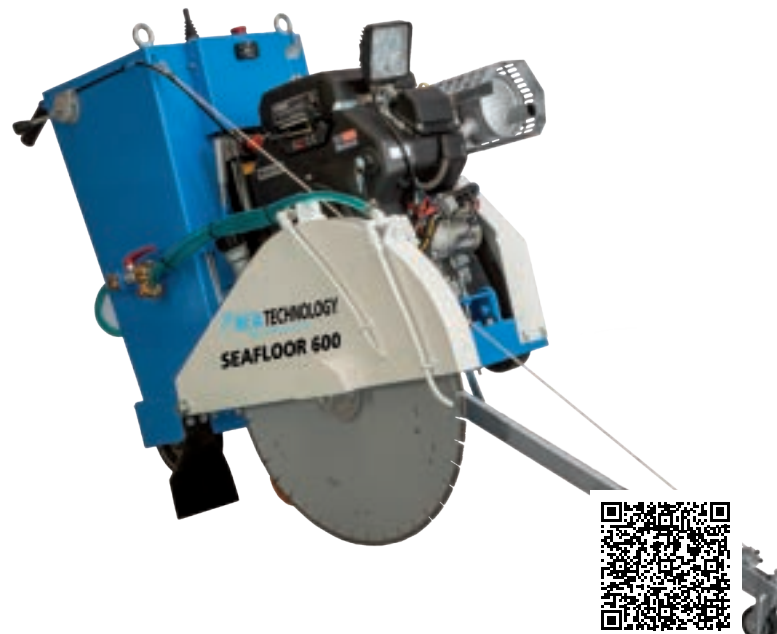











 Equipped with hour meter

# SEAFLOOR 600 A

SEAFLOOR600 A is the most suitable floor cutting machine for the demolition of old industrial floors or the cutting of micro trenching for fibre optics, due to its ability to make deep and demanding cuts up to 220mm deep.

Available with automatic advancement (Vanguard 35 HP). Ideal for machining large areas, it is equipped in both versions with automatic blade descent, hour counter and LED spotlight for lighting the cutting area.

## TECHNICAL DATA SHEET

 Diamond blade diameter 600 mm	 Equipped with hour meter
 Cutting depth 22 cm	 Automatic advancement
 Automatic blade descent	 Dimensions (LxWxH) 158x76x130
 Vanguard 35 HP petrol motor	 Weight 250 kg
 Rpm 3000 MIN -1	 According to EC standards











 Equipped with hour meter

# SEAFLOOR 801 D

SEAFLOOR801D is the joint size created for extremely demanding working conditions, where it impresses with its power and compactness. Equipped with a 3-cylinder Perkins diesel engine, it develops 18.4 kW / 25 hp and high torque, thanks to which it can mount blades with a diameter of up to 1000 mm. It can reach cutting depths of up to 415 mm. This machine has a hydrostatic drive and a low centre of gravity, elements that always ensure a fast and precise cut. The casing can be tilted upwards to make intersections, and there is the possibility of cutting both left and right by moving the blade in a short time.

## TECHNICAL DATA SHEET

 Diamond blade ø 1000 mm bore 25.4 mm	 Left and right blade mounting options
 Cutting depth 415 mm	 Dimensions (WxDxH) 1300x840x1690mm
 Perkins 3-cylinder diesel engine 18.4 kW / 25 hp	 Weight 458 kg
 Electric feed and depth adjustment	 According to EC standards





## SEAFLOOR 500 E

SEAFLOOR 500 E is the ideal floor saw for indoor work or in general where there is a need for emission-free cutting. The semi-automatic advance and depth adjustment of the blade via handwheel allows cuts up to 190 mm in maximum safety and comfort. The large 50 litre tank allows many hours of uninterrupted work.



### TECHNICAL DATA SHEET

Diamond cutting blade ø 500 mm, bore 25.4 mm	50 litre sheet metal water tank
Cutting depth 190 mm with blade ø 500 mm	Dimensions (HxWx-L) 1640x900x950
Semi-automatic feed and depth adjustment with handwheel	Weight 102 kg
Three-phase electric motor 400V/50 Hz-4kW	According to EC standards

## SEAFLOOR 801 E

SEAFLOOR801E is the ideal floor saw for cutting large areas, even indoors thanks to its powerful electric motor. Thanks to the use of a blade with a maximum diameter of 800mm, this machine allows cuts up to 320mm in maximum safety. The possibility of converting the cut from left to right and disassembling the motor in seconds make this one of the most ductile floor saw on the market.



**NEW**



### TECHNICAL DATA SHEET

Diamond cutting blade ø 800 mm, bore 25.4 mm + PIN	Weight 155 kg
Cutting depth 320 mm	According to EC standards
Three-phase electric motor 400V/50 Hz-11kW	Left and right blade mounting options
Dimensions (HxWx-L) 980x620x1080	

## SEAFLOOR1001 E/ES

SEAFLOOR1001ES is the ideal floor saw for cutting large areas. The powerful 15kw electric motor (22kw for the SEAFLOOR1001E model) and the 1000mm blade allow deep cuts up to 420mm in safety and comfort, thanks to the automatic feed and depth adjustment. The possibility of converting the cut from left to right and the rear wheel that rests outside the cutting area make joint trimming possible without any problems. The variable speed drive on the control panel guarantees the optimum speed according to the blade diameter used.



**NEW**



### TECHNICAL DATA SHEET

Diamond blade diameter 1000 mm, hole 25.4 mm	Right and left-hand blade mounting possible
Cutting depth 420 mm	Seafloor1001ES - Dimensions (WxDxH) 1500x795x1350mm Seafloor1001E - Dimensions (WxDxH) 1150x795x1350mm
Seafloor1001ES - 400V electric motor - 15 kW Seafloor1001E - 400V electric motor - 22 kW	Seafloor1001ES - Weight 369 kg Seafloor1001E - Weight 388 kg
Electro-hydraulic advance and depth adjustment	According to EC standards

# HIGH FREQUENCY

## SEACUT 400A ring

SEACUT 400A is a ring power cutter for cuts on reinforced concrete, masonry and natural stone of up to a depth of 300 mm. Thanks to high-frequency technology, this machine is extremely lighter, more powerful and easier to handle than any other motorised cutter with either a thermal or electric motor. The innovative three-point irrigation system allows the diamond ring to perform exceptionally well in terms of durability and speed, ensuring constant and uniform cooling. The high-strength roller drive system stands for robustness and easy maintenance.



### TECHNICAL DATA SHEET

	UoM	SINGLE PHASE	THREE-PHASE
Voltage	V	230	400
Max Power	W	3700	6500
Continuous power	W	2700	4800
Cutting depth	mm	300	300
Ring ø	mm	400	400
No. of revs	1/min	2000	2000
Weight	Kg	13.5	13.5



## SEACUT 400HF blade

400HF is a blade power cutter for cuts in reinforced concrete, masonry and natural stone of up to a depth of 165 mm. Thanks to its high-frequency technology and reduced flange, SEACUT 400HF is the best performing 400 mm diameter blade cutter on the market in terms of both maximum depth and cutting speed. The low weight ensures extreme manoeuvrability. Among the blades that can be used is the Laser Cinque, which allows the operator to cut reinforced concrete, iron, steel, wood, plastic and other materials with remarkable speed and, of course, safely.



### TECHNICAL DATA SHEET









	UoM	SINGLE PHASE	THREE-PHASE
Voltage	V	230	400
Max Power	W	3700	6500
Continuous power	W	2700	4800
Cutting depth	mm	165	165
Ring ø	mm	400	400
Spindle hole	mm	25.4	25.4
No. of revs	1/min	2500	2500
Weight	Kg	9.4	9.4



# SEACUT 450S rail

SEACUT 450S is a diamond rail saw for cuts in reinforced concrete and masonry of up to a depth of 165 mm. It reaches 1850 rpm in both single-phase and three-phase, delivering a maximum power of 3700 W in single-phase and 6500 W in three-phase. It is used with one or more guide rails with a length of 2.18 m, which guarantee a precise cut in total safety. SEACUT 450 S is certainly a very ductile cutting system, which can be used, for example, for door and window openings rather than for removing or trimming walls.

## TECHNICAL DATA SHEET









	UoM	SINGLE PHASE	THREE-PHASE
 Voltage	V	230	400
 Max Power	W	3700	6500
 Continuous power	W	2800	4800
 Cutting depth	mm	165	165
 Blade diameter ø	mm	450	450
 Spindle hole	mm	20	20
 No. of revs	1/min	2500	2500
 Weight	Kg	9.8	9.8



# SEACUT 500S rail

SEACUT 500S is a diamond rail saw for cuts in reinforced concrete and masonry of up to a depth of 210 mm. It reaches 1850 rpm in both single-phase and three-phase, delivering a maximum power of 3700 W in single-phase and 6500 W in three-phase. It is used with one or more guide rails with a length of 2.18 m, which guarantee a precise cut in total safety. SEACUT 500S is certainly a very ductile cutting system, which can be used, for example, for door and window openings rather than for removing or trimming walls.

## TECHNICAL DATA SHEET





	UoM	SINGLE PHASE	THREE-PHASE
 Voltage	V	230	400
 Max Power	W	3700	6500
 Continuous power	W	2700	4800
 Cutting depth	mm	210	210
 Blade diameter ø	mm	500	500
 Spindle hole	mm	20	20
 No. of revs	1/min	1850	1850
 Weight	Kg	12.5	12.5



# SEASAW 40

SEASAW40 is a chain saw capable of cutting reinforced concrete, masonry and natural stone up to a depth of 400 mm. Its performance is comparable to that delivered by cutting systems such as cutting machines using diamond blades with diameters of up to 1,200 mm. However, compared to these traditional systems, SEASAW 40 is much more manoeuvrable and requires considerably less energy, making it suitable for safe use by anyone. The supplied diamond chain provides an excellent compromise between cutting speed and durability, even on the most difficult materials.

## TECHNICAL DATA SHEET

	UoM	SINGLE PHASE	THREE-PHASE
 Voltage	V	230	400
 Max Power	W	3700	6500
 Continuous power	W	2700	4800
 Cutting depth	mm	405	405
 Bar length	mm	400	400
 No. of revs	1/min	5500	5500
 Weight	Kg	9.8	9.8



# SEADRILL 3700HF

SEADRILL 3700HF is a manual core drill for water core drilling on reinforced concrete, masonry and natural stone. It has an external 1"1/4 and internal 1/2 Gas connection and is prepared for column mounting. Thanks to the high rpm it reaches (600, 1400 or 2900 depending on the set motor speed), it is suitable for drilling from a diameter of 20 to a diameter of 150 mm. High frequency technology makes SEADRILL 3700 HF the most powerful core drilling motor on the market in relation to its small size.



## TECHNICAL DATA SHEET

	UoM	SINGLE PHASE	THREE-PHASE
Voltage	V	230	400
Max Power	W	3700	6500
Continuous power	W	2700	4800
Collar ø	mm	60	60
Length Total	mm	375	375
Weight	Kg	6.2	6.2
Fitted with 3 mechanically selectable motor speeds: 1 - 630 rpm 2 - 1400 rpm 3 - 2900 rpm			

# SEADRILL 3700HFRIG

SEADRILL 3700HFRIG is a high frequency motor suitable for water column drilling in reinforced concrete, masonry and natural stone. Thanks to the high rpm it reaches (600, 1400 or 2900 depending on the set motor speed), it is suitable for drilling from a diameter of 20 to a diameter of 150 mm. It can be mounted on either the aluminium STAND 200 column or the steel PSTAND 250 column. High frequency technology makes SEADRILL 3700HFRIG the most powerful core drilling motor on the market in relation to its small size.



## TECHNICAL DATA SHEET

	UoM	SINGLE PHASE	THREE-PHASE
Voltage	V	230	400
Max Power	W	3700	6500
Continuous power	W	2700	4800
Collar ø	mm	60	60
Length Total	mm	375	375
Weight	Kg	6.2	6.2
Fitted with 3 mechanically selectable motor speeds: 1 - 630 rpm 2 - 1400 rpm 3 - 2900 rpm			

# SEACUT 400HF6D

The water-cooled SEACUT 400HF6D frequency converter can autonomously control all the high frequency machines of the SEA Technology range, excluding the SEACUT 900S wall cutter. By means of the specifically coded plug, the various devices are identified by the converter and the individual settings are applied to them. The frequency converter can run in both single-phase and three-phase, according to the electrical availability of the site. The maximum power is 230V – 3700W and 400V – 6500W. The status and error signals are indicated to the user via a display fitted directly on the frequency converter.



## TECHNICAL DATA SHEET

	UoM	SINGLE PHASE	THREE-PHASE
Voltage	V	230	400
Max Power	W	3700	6500
Weight	kg	6	6

Fitted with a display with identification of the machine used



# SEACUT 900S







SEACUT 900S is a high-frequency, rail-mounted wall cutting machine, suitable for cutting reinforced concrete, stone and brick. It allows cuts up to a maximum depth of 390 mm. The high-frequency motor is water-cooled, with a three-phase power supply and a continuous output of 14 kW. Thanks to the practical wireless remote control, you can operate the machine safely.

SEACUT 900S comes with a practical trolley to easily transport all the kit:  
1 wall saw SEACUT 900S, 1 frequency converter SEACUT 900FU15D, 1 casing  $\varnothing$  750mm,  
1 x 2.18m rail, 2 x fixing staples, 2 x end stops, 1 x wireless controller, 1 x kit trolley.



NEW

## TECHNICAL DATA SHEET

	UoM	THREE-PHASE
 Voltage	V	400
 Max Power	kW	14
 Starting blade $\varnothing$	mm	750
 Maximum usable blade $\varnothing$	mm	914
 Blade bore $\varnothing$	mm	25.4
 Maximum depth	mm	390
 Head weight with engine and crankcase	Kg	37.5





# SEACUT 900FU15D

The water-cooled SEACUT 900FU15D frequency converter can autonomously control all the high frequency machines of the SEA Technology range, including the SEACUT 900S wall cutter. By means of the specifically coded plug, the various devices are identified by the converter and the individual settings are applied to them. The frequency converter is three-phase, with a maximum power output of 15,000W. The status and error signals are indicated to the user via a display fitted directly on the frequency converter.



NEW

## TECHNICAL DATA SHEET

	UoM	THREE-PHASE
 Voltage	V	400
 Power output	W	15000
 Output frequency	Hz	100 - 980
 Weight	kg	6

Fitted with a display with identification of the machine used



# WATER DIAMOND CROWNS



## CORONA TRE 450

Laser-welded diamond core drill, top of the range for water-cooled use on core drills with 1"1/4 male motor connection. Spiralling significantly speeds up the drilling time, making it easier for the material to escape from the hole seat, which tends to get stuck during use. It is ideal for professional users who do not want any surprises on site and who always seek maximum performance. On request, crowns can be regrooved, but only by braze welding.

SPIRAL STEEL

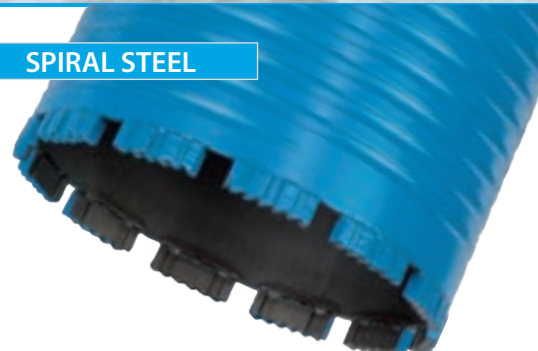

### TECHNICAL DATA SHEET

cured concrete, bricks, tiles, reinforced concrete	★★★★★	<b>SUPER</b>
	★★★★	<b>EXCELLENT</b>
refractory, granite, natural stone, porphyry, sandstone, gravel slabs	★★★	<b>GOOD</b>
	★★	<b>MEDIUM</b>
single-fired, double-fired, fresh concrete, asphalt	★	<b>SUFFICIENT</b>
marble, porcelain stoneware, klinker		<b>INADEQUATE</b>



FOR USE  
WATER



FITTING  
1"1/4 F



LENGTH  
450 MM

### AVAILABLE Ø

12 - 14 - 15 - 16 - 18 - 20 - 21 - 22 - 24 25 - 26  
28 - 30 - 31 - 35 - 41 - 45 - 51 56 - 61 - 66 - 71  
76 - 81 - 86 - 91 - 101 107 - 111 - 121 - 127 - 131  
141 - 151 161 - 171 - 181 - 205 - 215 - 225 - 250  
300 - 350 - 400 - 450 - 500

From ø 12 to ø 132 also available with 1/2 gas connection



# CORONA TRE 450 1/2 Gas

Laser-welded diamond core drill, top of the range for water-cooled use on core drills with 1/2 gas connection to the motor. Spiralling significantly speeds up the drilling time, making it easier for the material to escape from the hole seat, which tends to get stuck during use. It is ideal for professional users who do not want any surprises on site and who always seek maximum performance. On request, crowns can be regrooved, but only by braze welding.



TECHNICAL DATA SHEET		
cured concrete, bricks, tiles, reinforced concrete		<b>SUPER</b>
		<b>EXCELLENT</b>
refractory, granite, natural stone, porphyry, sandstone, gravel slabs		<b>GOOD</b>
		<b>MEDIUM</b>
single-fired, double-fired, fresh concrete, asphalt		<b>SUFFICIENT</b>
marble, porcelain stoneware, klinker		<b>INADEQUATE</b>

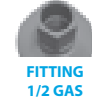

AVAILABLE Ø
12 - 14 - 15 - 16 - 18 - 20 - 21 - 22 - 24 - 25 - 26 - 28 - 32 - 35 - 38 - 42 - 45 - 52 - 56 - 62 - 66 - 72 - 76 - 82 - 86 - 92 - 102 - 112 - 122 - 132



# CORONA DUE 450

Of traditional design but with laser-welded segments, this crown has the same cutting characteristics as CORONA TRE 450, but with a lower drilling speed due to the absence of the spiral. It is particularly suitable for customers looking for an excellent product, well protected from segment breakage by laser welding. On request, crowns can be regrooved, but only by braze welding.



TECHNICAL DATA SHEET		
		<b>SUPER</b>
cured concrete, bricks, tiles, reinforced concrete		<b>EXCELLENT</b>
sandstone, gravel slabs		<b>GOOD</b>
granite, natural stone, porphyry		<b>MEDIUM</b>
single-fired, double-fired, fresh concrete, asphalt		<b>SUFFICIENT</b>
marble, porcelain stoneware, klinker		<b>INADEQUATE</b>

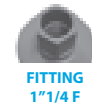

AVAILABLE Ø
31 - 35 - 41 - 45 - 51 - 56 - 61 - 66 - 71 - 76 - 81 - 86 - 91 - 101 - 107 - 111 - 121 - 127 - 131 - 141 - 151 - 161 - 171 - 181 - 205 - 225 - 250 - 260 - 272 - 300 - 350 - 400* - 450* - 500* - 550* - 600* - 700* - 800* - 900* - 1000*



\* braze-welded

# CORONA DUE 450 BRAZED

Of traditional design but with brazed segments, this crown has the same cutting characteristics as CORONA TRE 450, but with a lower drilling speed due to the absence of the spiral. On request, crowns can be regrooved.

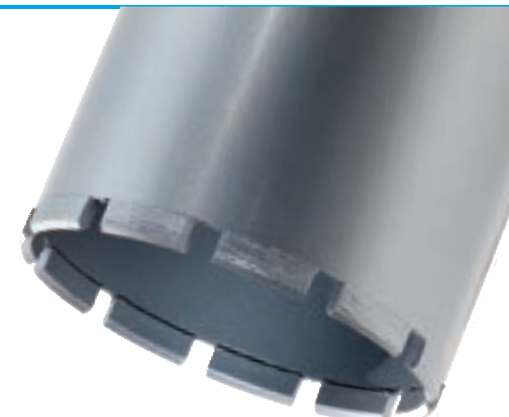

TECHNICAL DATA SHEET		
		<b>SUPER</b>
cured concrete, bricks, tiles, reinforced concrete		<b>EXCELLENT</b>
sandstone, gravel slabs		<b>GOOD</b>
granite, natural stone, porphyry		<b>MEDIUM</b>
single-fired, double-fired, fresh concrete, asphalt		<b>SUFFICIENT</b>
marble, porcelain stoneware, klinker		<b>INADEQUATE</b>



AVAILABLE Ø
400 - 450 - 500 - 550 - 600 - 700 - 800 - 900 - 1000



brazed

# CORONA UNO 450

The CORONA UNO 450 has been specially created for the professional user of controlled demolition. The composition of the diamond segment guarantees high output combined with good cutting speed. Laser welding increases safety. This crown can also be used on high-power three-phase machines.



TECHNICAL DATA SHEET		
cured concrete, bricks, tiles, reinforced concrete		<b>SUPER</b>
sandstone, gravel slabs		<b>EXCELLENT</b>
granite, natural stone, porphyry		<b>GOOD</b>
single-fired, double-fired, fresh concrete, asphalt		<b>MEDIUM</b>
marble, porcelain stoneware, klinker		<b>SUFFICIENT</b>
		<b>INADEQUATE</b>

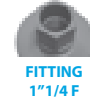

**AVAILABLE Ø**  
 31 - 35 - 41 - 45 - 51 - 56 - 61 - 66  
 - 71 - 76 - 81 - 86 - 91 - 101 - 107  
 - 111 - 121 - 127 - 131 - 141 - 151  
 - 161 - 171 - 181 - 205 - 225 - 250  
 - 300



## CONTINUOUS CORING

This line of diamond core bits is suitable for holes deeper than 2 metres. Since it is not possible to extract the core from the wall, as with traditional core drilling, this system allows the hole to be drilled by screwing the extensions into each other while keeping the core inside the crown. On request, they can be supplied with extractors and stabilisers for the crowns to prevent them from deviating. The tool is available in three variants: Impregnated, Set or Polycrystalline crowns that can be ordered for use with water or compressed air. SEA Technology recommends that you contact your company technician for preventive advice as this is a highly technical core drilling system.

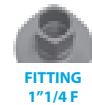

TECHNICAL DATA SHEET	
<b>IMPREGNATED CROWNS</b>	
<b>Suitable for drilling:</b> Granite - Porphyry - Stone - Concrete - Reinforced Concrete - Heavily Reinforced Concrete	
<b>MOD.</b>	<b>MATERIAL</b>
<b>Mx1</b>	For soft materials
<b>Mx3</b>	For medium materials, e.g. reinforced concrete
<b>Mx4</b>	For medium-hard materials, e.g. heavily reinforced concrete
<b>Mx5</b>	For hard materials, e.g. granite
<b>SET CROWNS</b>	
<b>Suitable for drilling:</b> Hollow Brick - Solid Brick - Unreinforced Concrete - Marble - Clay - Sandstone - Limestone Materials	
<b>POLYCRYSTALLINE CROWNS</b>	
<b>Suitable for drilling:</b> Hollow Brick - Solid Brick - Tuff Lime - Gypsum	



## FAST CONTINUOUS CORING

This line of diamond core bits is suitable for core depths between 1 and 6 metres and a maximum diameter of 127 mm. In contrast to conventional continuous coring, fast continuous coring has significantly reduced weights due to the thickness of the steel comparable to a conventional diamond core drill. For the same reason, it is possible to use conventional water-cooled core drills with power between 2600 and 4200 W. Compared to traditional coring, this system allows the hole to be drilled by screwing the extensions into each other while keeping the core inside the crown.

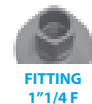

TECHNICAL DATA SHEET	
<b>IMPREGNATED CROWNS</b>	
<b>Suitable for drilling:</b> Granite - Porphyry - Stone - Concrete - Reinforced Concrete - Heavily Reinforced Concrete	









# DIAMOND DRY CROWNS

## CORONA TRE 300 DUST SUCTION SYSTEM

Dry drilling crown with dust extraction system. This model, like all others in the dry range, was also developed for waterless drilling in reinforced concrete. For mounting on manual core drills, requires rotary head (see accessories page). The usable drilling length is 300 mm, the overall length including attachment is 370 mm. If required, it can be used with water on core drills with direct 1"1/4 male connection.

### TECHNICAL DATA SHEET

cured concrete, bricks, tiles, reinforced concrete		<b>SUPER</b>
		<b>EXCELLENT</b>
granite, natural stone, porphyry		<b>GOOD</b>
refractory		<b>MEDIUM</b>
sandstone, gravel slabs, single-fired, double-fired, fresh concrete, asphalt		<b>SUFFICIENT</b>
marble, porcelain stoneware, klinker		<b>INADEQUATE</b>

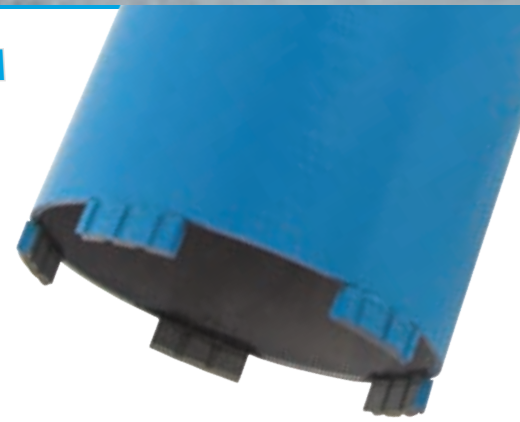

FOR USE  
DRY



FITTING  
1"1/4 F



LENGTH 300 MM  
(ø 182 and ø 205 L. 200 mm)

### AVAILABLE Ø

32\* - 37\* - 42\* - 52\* - 57 - 62 - 68  
72 - 82 - 92 102 - 107 - 112 - 122  
127 - 132 - 142 - 152 - 162 - 182 -  
205 - 225 - 250





\* Also available with 1/2 gas connection L.300 mm



## CORONA TRE 150

The conical body, spiral and segment design make this diamond crown unique and unsurpassed in performance. At the top of the range, it is ideal for professional users who make no compromises: it cuts everything, including iron, at a speed never experienced before. The conical body reduces lateral friction and increases drilling speed, aided by the spiral that bludgeons material and avoids crown locking. **The design and composition of the diamond segment were developed for dry core drilling.**

### TECHNICAL DATA SHEET

cured concrete, bricks, tiles, reinforced concrete		<b>SUPER</b>
		<b>EXCELLENT</b>
granite, natural stone, porphyry		<b>GOOD</b>
refractory		<b>MEDIUM</b>
sandstone, gravel slabs, single-fired, double-fired, fresh concrete, asphalt		<b>SUFFICIENT</b>
marble, porcelain stoneware, klinker		<b>INADEQUATE</b>



### SPIRAL STEEL



FOR USE  
DRY



FITTING  
M16 F



LENGTH  
150 MM

### AVAILABLE Ø

32 - 37 - 42 - 52 - 57 - 62 - 68 - 72 -  
82 92 - 102 - 107 - 112 - 122 - 127  
- 132 - 142 - 152 - 162 - 182 - 205  
- 225 - 250



# CORONA DUE 150

Crown produced to traditional standards, but also suitable for cutting dry concrete. Compared to CORONA TRE 150 it is less performing in terms of drilling speed, it is more suitable for a public that does not make intensive use of the crown (e.g. construction companies) who will appreciate the excellent price/quality ratio.



TECHNICAL DATA SHEET		
cured concrete, bricks, tiles		<b>SUPER</b>
		<b>EXCELLENT</b>
reinforced concrete		<b>GOOD</b>
refractory, granite, natural stone, porphyry, sandstone, gravel slabs		<b>MEDIUM</b>
single-fired, double-fired, fresh concrete, asphalt		<b>SUFFICIENT</b>
marble, porcelain stoneware, klinker		<b>INADEQUATE</b>



**AVAILABLE Ø**  
 32 - 37 - 42 - 52 - 57 - 62 - 68 - 72 - 82 - 92  
 102 - 107 - 112 - 122 - 127 - 132 - 142  
 152 - 162 - 182 - 205



# CORONA DUE 45 GRES

The 'CORONA DUE 45 GRES' core drill is designed for dry core drilling of the hardest materials such as porcelain stoneware, klinker and granite. The M14 connection makes it ductile in that it can be mounted on any grinder.



FOR USE  
DRY



FITTING  
M14



LENGTH  
45 MM



TECHNICAL DATA SHEET		
porcelain stoneware		<b>SUPER</b>
		<b>EXCELLENT</b>
		<b>GOOD</b>
		<b>MEDIUM</b>
		<b>SUFFICIENT</b>
		<b>INADEQUATE</b>

**AVAILABLE Ø**  
 6 - 8 - 10 - 12 - 14  
 cylindrical coupling



**AVAILABLE Ø**  
 6 - 8 - 10 - 12 - 14 - 16 - 20  
 25 - 30 - 35 - 40 - 45 - 50 - 55  
 60 - 70 - 80 - 90 - 100  
 M14 fitting



# CORING CONSTRUCTION MACHINERY

## SEADRILL 1800

Thanks to its performance, the SEADRILL 1800 is the undisputed leader in dry core drilling. Unique features such as high power, micro-percussion and double clutch, concentrated in a single machine allow the SEADRILL 1800 to safely use drills up to 205 mm diameter, even in reinforced concrete and with dust extraction, thanks to the fitting of the special kit.



### TECHNICAL DATA SHEET

Power input: 1800 W - 230 V

Speed: 1650 rpm

Weight 5.8 kg

Max. drilling diameter: 205 mm

Mechanical Clutch and Electronic Clutch

According to EC standards

Micropercussion: 36000 strokes/min at 0.1 joule

Supplied with coring machine case and accessories



## SEADRILL 1600A

Thanks to its performance, SEADRILL 1600A is the undisputed leader in anchoring. Thanks to its high RPM (9000 rpm) and low weight, it can drill holes up to 60 mm diameter at exceptional speed, even in heavily reinforced concrete. SEADRILL 1600 A is preset for mounting on the SEASTAND 200 column.



### TECHNICAL DATA SHEET

Power input: 1600 W - 230 V

Speed: 9000 rpm

Weight 6 kg

Max. drilling diameter: 60 mm

Integrated prcd switch

According to EC standards

Gas fitting 1"1/4 + 1/2

Supplied with coring machine case and accessories



# SEADRILL 2000A

SEADRILL 2000A is a core drill that makes ductility its strong point. Excellent for manual core drilling even on reinforced concrete with M16-mounted core bits through the special adapter, it is also a powerful wet core drill thanks to the 1/2 gas and 1"1/4 connection and the provision for column mounting. It is wet core drilling with small diameters, however, that is its real strength, thanks to the high number of revolutions, an impressive 2520, that it can achieve. Applying the special suction kit also allows the use of the CORONE DUE 300.



## TECHNICAL DATA SHEET

- Power input: 2000 W - 230 V
- Max. drilling diameter: 160 mm
- Gas fitting 1"1/4 + 1/2

- 3 mechanically selectable motor speeds.  
1 - 540 rpm 2 - 1200 rpm 3 - 2520 rpm
- Integrated prcd switch

- Supplied with case coring machine case and accessories
- Weight 7 kg
- According to EC standards



# SEADRILL 2000

Thanks to its special features, SEADRILL 2000 is the undisputed leader in dry core drilling with dust suction system. Equipped with a powerful 2000 W motor and micro-percussion, SEADRILL 2000 allows core drilling up to 205 mm diameter, even on reinforced concrete, either manually or on a column. The low weight and small dimensions make all types of drilling easy and safe. For proper use of the SEADRILL 2000, we recommend the centring piston.



**NEW**

## TECHNICAL DATA SHEET

- Power input: 2000W - 230V
- Max. drilling diameter: 205mm
- Gas fitting 1"1/4 + 1/2

- 2 mechanically selectable motor speeds.  
1 - 900 rpm  
2 - 2000 rpm
- Rpm under load: 540 / 1200

- Supplied with case coring machine case and accessories
- Weight 5 kg



# SEADRILL 200 ASP

SEADRILL 200ASP is obtained by mounting SEADRILL 2000 on the SEASTAND 200 column and is a core drilling system with dust suction system up to diameter 250 mm. It is characterised by its versatility due to its favourable power-to-weight ratio and the fact that it can be fixed either by means of the dowel provided or by vacuum fixing for which it is already prepared. 45° inclined core drilling is possible. Small steel base for easier positioning.



**NEW**

## TECHNICAL DATA SHEET

- Motor: SEADRILL 2000
- Gas fitting 1"1/4 + 1/2
- Suitable for max bores of 250 mm
- Useful stroke: 510mm  
Column height: 850mm
- Quick motor release

- Rack and column in a single casting
- Steel base
- 45° tilting
- Column weight: 11.5 kg  
Motor weight: 5 kg
- According to EC standards



# SEADRILL 200

SEADRILL 200 is obtained by mounting SEADRILL 2000A on SEASTAND COLUMN 200 and is a core drilling system for holes up to 205 mm. It is characterised by its versatility due to its favourable power-to-weight ratio and the fact that it can be fixed either by means of the dowel provided or by vacuum fixing for which it is already prepared. 45° inclined core drilling is possible. Small steel base for easier positioning.



## TECHNICAL DATA SHEET

Motor: SEADRILL 2000A	Rack and column in a single casting
Connection: 1"1/4 and 1/2 Gas	Steel base
Suitable for max bores of 205 mm	45° tilting
Useful stroke: 510 mm Column height: 850 mm	Column weight: 11.5 kg Motor weight: 7.3 kg
Quick motor release	According to EC standards

# SEADRILL 250

SEADRILL 250 consists of the SEM26 motor and the SEASTAND 250 COLUMN and is capable of safely drilling up to 250 mm. It is distinguished by its ease of use thanks to the quick release of the motor and the ease of transport via the wheels provided. Fastening can be carried out with a dowel or by vacuum pump. With the SEADRILL 250 it is also possible to carry out inclined core drilling up to a maximum of 45°. Small steel base for easier positioning.

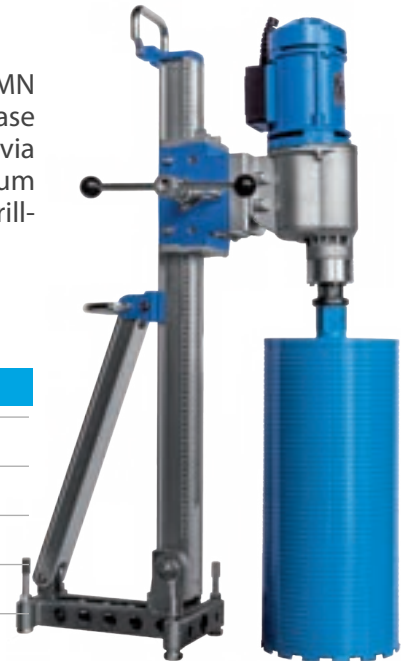

## TECHNICAL DATA SHEET

Water operated with 2600 W - 230 V motor	Quick motor release
3 mechanically selectable motor speeds. 1 - 550 rpm 2 - 1070 rpm 3 - 1630 rpm	Steel base
Connection: 1"1/4 and 1/2 Gas	45° tilting
Suitable for max bores of 250 mm	Column weight: 13 kg
Useful stroke: 580 mm Column height: 900 mm	Motor weight: 11.9 kg

# SEADRILL 300

Consisting of the SEASTAND 300 COLUMN and the SEM 32 motor, SEADRILL 300 allows drilling up to a diameter of 300, by fitting the spacer provided, while maintaining the same technical characteristics as SEADRILL 250. The column's greater height and up to 45° inclination make it ideal for continuous drilling.



## TECHNICAL DATA SHEET

Water operated with 3200 W - 230 V motor	Quick motor release
3 mechanically selectable motor speeds. 1 - 420 rpm 2 - 820 rpm 3 - 1250 rpm.	Wheels supplied
Connection: 1"1/4	45° tilting
Suitable for max bores of 300 mm	Column weight: 18 kg
Useful stroke: 800 mm Column height: 1245 mm	Motor weight: 11.9 kg

# SEADRILL 350

SEADRILL 350 is the core drill suitable for holes up to a diameter of 350. SEASTAND 400 COLUMN takes full advantage of the large torque of the SEM 32 motor, thanks to which it is possible to carry out multiple large core drillings without any difficulty. Allows holes inclined by 45°.



## TECHNICAL DATA SHEET

Water operated with 3200 W - 230 V motor	Quick motor release
3 mechanically selectable motor speeds. 1 - 420 rpm 2 - 820 rpm 3 - 1250 rpm.	Wheels supplied
Connection: 1"1/4	45° tilting
Suitable for max bores of 350 mm	Column weight: 19 kg Motor weight: 11.9 kg
Useful stroke: 500 mm Column height: 980 mm	

# SEADRILL 400

SEADRILL 400 is the largest core drill in the seadrill range, suitable for holes up to a diameter of 400. The system consisting of SEASTAND 400 COLUMN and the SEM42 three-phase motor is specially designed for drilling large diameters in large series. In fact, the motor is designed to withstand prolonged stresses such as continuous drilling. Like the SEADRILL 350, it allows 45° inclined core drilling.



## TECHNICAL DATA SHEET

Water operated with 3900 W - 400 V motor	Quick motor release
3 mechanically selectable motor speeds. 1 - 160 rpm 2 - 340 rpm 3 - 510 rpm	Wheels supplied
Connection: 1"1/4	45° tilting
Suitable for max bores of 400 mm	Column weight: 19 kg Motor weight: 19 kg
Useful stroke: 500 mm	

# SEACORE 200

SEACORE 200 consists of the professional PSTAND 200 column, already equipped with a vacuum attachment system, and the SEADRILL 2000A water core drill. This series of core drills differs from the SEADRILL range in the features of the columns built for highly professional use. The material used, the precision and robustness of all components, and above all the obsessive attention to detail make them perfect for those who make core drilling their job. Note the 3 mm thick steel with which they are constructed, the rack on the side opposite the motor to keep it clean during use, and the steel bearings of the motor carriage with patented design for greater durability. It allows holes inclined by 80°, up to a maximum diameter of 181 mm.

**NEW**



## TECHNICAL DATA SHEET

Motor: SEADRILL2000A	80° tilting
Connection: 1"1/4 and 1/2 Gas	Column weight: 9.5 kg Motor weight: 7 kg
Suitable for max bores of 181 mm	According to EC standards
Useful stroke: 514 mm Column height: 770mm	
Rack opposite the motor	

# SEACORE 200 ASP









SEACORE 200ASP differs from SEACORE 200 in that it consists of the professional PSTAND 200 column and the SEADRILL 2000 core drill with integrated dust suction system.

It allows holes inclined by 80°, up to a maximum diameter of 181 mm.

NEW











## TECHNICAL DATA SHEET

 <b>Motor: SEADRILL 2000</b>	 <b>80° tilting</b>
 <b>Connection: 1"1/4 and 1/2 Gas</b>	 <b>Column weight: 9.5 kg Motor weight: 5 kg</b>
 <b>Suitable for max bores of 181 mm</b>	 <b>According to EC standards</b>
 <b>Useful stroke: 514 mm Column height: 770mm</b>	
 <b>Rack opposite the motor side</b>	

# SEACORE 250

SEACORE 250 consists of the professional PSTAND 250 column and the SEM 26 motor. This series of core drills differs from the SEADRILL range in the features of the columns built for highly professional use. The material used, the precision and robustness of all components, but above all the obsessive attention to making them perfect for those who make core drilling their job, identify these core drills as the absolute reference in controlled demolition. Note the 3 mm thick steel with which they are constructed, the rack on the side opposite the motor to keep it clean during use, the steel bearings of the motor carriage with patented design for greater durability, and the ultra-rapid motor release system, useful in tight spaces. It allows for 60° inclined holes at the front and rear.

## TECHNICAL DATA SHEET









 <b>Water operated with 2600 W - 230 V motor</b>	 <b>Quick motor release</b>
 <b>3 mechanically selectable motor speeds. 1 - 550 rpm 2 - 1070 rpm 3 - 1630 rpm</b>	 <b>Rack opposite the motor side</b>
 <b>Connection: 1"1/4 and 1/2 Gas</b>	 <b>60° tilting</b>
 <b>Suitable for max bores of 250 mm</b>	 <b>Column weight: 16 kg Motor weight: 11.9 kg</b>
 <b>Useful stroke: 590 mm</b>	



# SEACORE 350

SEACORE 350 consists of the PROFESSIONAL COLUMN PSTAND250 and the SEM 32 motor; Seacore 350 allows safe core drilling up to a diameter of 350 mm, by fitting the special spacer provided, while maintaining the same technical characteristics as the Seacore 250.

## TECHNICAL DATA SHEET

 <b>Water operated with 3200 W - 230 V motor</b>	 <b>Quick motor release</b>
 <b>3 mechanically selectable motor speeds. 1 - 420 rpm 2 - 820 rpm 3 - 1250 rpm.</b>	 <b>Rack opposite the motor side</b>
 <b>Connection: 1"1/4</b>	 <b>60° tilting</b>
 <b>Suitable for max bores of 350 mm</b>	 <b>Column weight: 16 kg Motor weight: 11.9 kg</b>
 <b>Useful stroke: 590 mm</b>	



# SEACORE 350 P

SEACORE 350P consists of the PSTAND250 Professional Column and the SEM 32P motor, by fitting the spacer provided, the Seacore 350 makes it possible to safely drill holes up to a diameter of 350 mm, but at a higher speed than conventional column water core drilling thanks to the unique **micro-percussion** system. In addition, thanks to this system and in conjunction with the adaptor provided, the Seacore 350P is capable of dry core drilling in brick, natural stone and reinforced concrete

NEW



## TECHNICAL DATA SHEET

- |  |  |
|--|--|
| Water operated with 3200 W - 230 V motor   | Quick motor release                        |
| 3 mechanically selectable motor speeds.<br>1 - 420 rpm 2 - 820 rpm 3 - 1250 rpm. | Rack opposite the motor side               |
| Connection: 1"1/4  | 60° tilting                                |
| Suitable for max bores of 350 mm   | Column weight: 16 kg Motor weight: 12.4 kg |
| Useful stroke: 590 mm  |  |

# SEACORE 400

SEACORE 400 using the SSR38 motor and the PSTAND400 PROFESSIONAL COLUMN allows core drilling jobs up to 400 mm in size, even in large series, thanks to the considerable power of 3700 watts. The quick release system allows the motor to be removed even in small spaces, making even the most difficult jobs easier. The aluminium base with a very slim design lightens the system while still keeping it robust. It does not require large surfaces for fixing. It allows for 60° inclined holes at the front and rear.



## TECHNICAL DATA SHEET

- |  |  |
|--|--|
| Water operated with 3700 W - 230 V motor   | Suitable for max bores of 400 mm         |
| Full speed (1/min)<br>Motor level 1: 180-220-260-320-380-440<br>Motor level 2: 360-430-520-630-755-880<br>Motor level 3: 560-670-810-980-1180-1370 | Useful stroke: 690 mm Tilting at 60°     |
| Speed: 6 electronic and 3 manual.<br>Spd.Tot: 18   | Quick motor release                      |
| Connection: 1"1/4  | Rack opposite the motor side             |
|  | Column weight: 26 kg Motor weight: 16 kg |

# SEACORE 500

SEACORE 500 uses the SEM 52 motor and the PSTAND400 PROFESSIONAL COLUMN and is particularly suitable for heavy-duty work. Thanks to the supplied spacer, the system is capable of drilling up to 500 mm diameter and up to a maximum depth of 690 mm. Wheels facilitate handling. The system allows holes inclined by 60° at the front and rear.



## TECHNICAL DATA SHEET

- |  |  |
|--|--|
| Water driven with 5200 W motor - 400V  | Quick motor release                        |
| 3 mechanically selectable motor speeds.<br>1 - 140 rpm 2 - 280 rpm 3 - 430 rpm | Column height: 1350 mm                     |
| Connection: 1"1/4  | 60° tilting                                |
| Suitable for max bores of 500 mm   | Column weight: 26 kg Motor weight: 22.9 kg |
| Useful stroke: 690 mm  |  |











# SEACORE 600

SEACORE 600 uses the PSTAND600 PROFESSIONAL COLUMN and the three-phase SSR75 motor. In this way, the column's performance can be fully utilised, and therefore drillings up to a diameter of 600 mm and a maximum depth of 1090 mm are possible. The system allows holes inclined by 60° at the front and rear.



## TECHNICAL DATA SHEET

 Water operated with 7500 W - 400 V motor	 Quick motor release
 15 mechanically selectable motor speeds.	 Rack opposite the motor side
 Connection: 1"1/4	 60° tilting
 Suitable for max bores of 600 mm	 Column weight: 37 kg Motor weight: 19.5 kg
 Useful stroke: 1090 mm	











# SEACORE 1000

SEACORE 1000 is the top of the range. It uses the PSTAND1000 PROFESSIONAL COLUMN and the SSR75 three-phase motor. This system with 7500 W power allows core drilling of 1000 mm diameter and 1080 mm depth without the use of extensions. Equipped with a stabiliser, it is particularly suitable for continuous drilling of large diameters, the PROFESSIONAL COLUMN 1000 allows holes inclined by 60° both at the front and rear.



## TECHNICAL DATA SHEET

 Water operated with 7500 W - 400 V motor	 Quick motor release
 15 mechanically selectable motor speeds.	 Rack opposite the motor side
 Connection: 1"1/4	 60° tilting
 Suitable for max bores of 1000 mm	 Column weight: 37 kg Motor weight: 19.5 kg
 Useful stroke: 1080 mm	



# CORING EQUIPMENT

## COLUMN SEASTAND 200



### TECHNICAL DATA SHEET

- Material: aluminium, steel base
- Weight: 11,5 kg
- Useful stroke: 510 mm
- Column height: 850 mm
- Max capacity:  $\varnothing$  205 mm
- 45° tilting
- Preset for anchor fastening

## COLUMN SEASTAND 250



### TECHNICAL DATA SHEET

- Material: aluminium, steel base
- Weight: 13 kg
- Useful stroke: 580 mm
- Column height: 900 mm
- Max capacity:  $\varnothing$  250 mm
- 45° tilting
- Preset for anchor fastening

## COLUMN SEASTAND 300



### TECHNICAL DATA SHEET

- Material: aluminium
- Weight: 18 kg
- Useful stroke: 800 mm
- Accessories: not included
- Max capacity:  $\varnothing$  300 mm
- Features: column height
- Sliding: with Teflon bearings

## COLUMN SEASTAND 400



### TECHNICAL DATA SHEET

- Material: aluminium
- Weight: 19 Kg
- Useful stroke: 500 mm
- Accessories: not included
- Max capacity:  $\varnothing$  400 mm
- Features: remarkable stability
- Sliding: with Teflon bearings

## PROFESSIONAL COLUMN PSTAND 200

NEW



### TECHNICAL DATA SHEET

- Material: steel
- Weight: 9.5 Kg
- Useful stroke: 514 mm
- Accessories: vacuum system included
- Max capacity:  $\varnothing$  181 mm
- Features: robustness and precision
- Sliding: via steel bearings

## PROFESSIONAL COLUMN PSTAND 250



### TECHNICAL DATA SHEET

- Material: steel
- Weight: 16 Kg
- Useful stroke: 550 mm
- Accessories: not included
- Max capacity:  $\varnothing$  250 mm
- Features: robustness and precision
- Sliding: via steel bearings

## PROFESSIONAL COLUMN PSTAND 400



### TECHNICAL DATA SHEET

- Material: steel
- Weight: 26 kg
- Useful stroke: 690 mm
- Accessories: not included
- Max capacity:  $\varnothing$  400 mm
- Features: robustness and precision
- Sliding: via steel bearings

## PROFESSIONAL COLUMN PSTAND 600



### TECHNICAL DATA SHEET

- Material: steel
- Weight: 37 kg
- Useful stroke: 1090 mm
- Accessories: not included
- Max capacity:  $\varnothing$  600 mm
- Features: robustness and precision
- Sliding: via steel bearings

## PROFESSIONAL COLUMN PSTAND 1000



### TECHNICAL DATA SHEET

Material: steel

Weight: 37 kg

Useful stroke: 1080 mm

Accessories: not included

Max capacity:  $\varnothing$  1000 mm

Features: robustness and precision

Sliding: via steel bearings

## TELESCOPIC COLUMN SEASTAND 250 DELUXE

Can be used for horizontal drilling with SEADRILL 200 and SEADRILL 250. Avoids wall-mounting of equipment. Equipped with a water collection kit, 8 wheels for positioning and 2 gas springs for height adjustment.



## TELESCOPIC COLUMN SEASTAND 250/400

For horizontal drilling with SEADRILL 250 and SEADRILL 400. Avoids wall-mounting of equipment.



## PIPE COLUMN SEAPIPE

It simplifies manual drilling on curved surfaces, such as large diameter concrete pipes.



## PNEUMATIC BALANCER SEALIFTER

SEALIFTER is the first pneumatic balancer in the SEA Technology range. Patented to be installed on any aerial platform, it allows most tasks to be performed safely and in control, reducing physical effort and the likelihood of injury. The consequence is, in addition to precision performance, an important increase in productivity.

The SEALIFTER relieves the operator from carrying heavy tools for long periods, reducing their weight and increasing control: the result is a significant reduction in physical effort as well as total safety in the machining process. Among the available accessories is the trolley carriage, which allows safe operation with ample freedom of movement from the ground up to a height of 2.12 m.

All of SEALIFTER's movements are controlled by a pneumatic compensation unit,

which allows all the movements of the industrial manipulator arm to be controlled easily and without other tools: ascent, descent, instantaneous stop, tool guidance and control, and safety stop at the end of the job.



NEW





SEALIFTER BALANCER  
FOR AERIAL PLATFORM  
GUARDRAIL



SEALIFTER  
BALANCER ON  
TROLLEY

### TECHNICAL DATA SHEET

 <b>BALANCER</b> Weight: 25 kg - Dimensions: 322x1170x176 mm
 <b>CLAMPING SYSTEM TO THE GUARDRAIL</b> Weight: 6 Kg x 2 - Dimensions: 60x750x140 mm (single piece)

 <b>TOOL ARM</b> Weight: 6.5 kg - Dimensions: 850x185x90 mm - Max. applicable weight: 18 kg
 <b>TROLLEY</b> Weight: carriage 33 kg and ballast 50 kg - Dimensions: 740x1130x940 mm



# SEM AND SSR MOTORS

## SEM 26 MOTOR

### TECHNICAL DATA SHEET

Rated voltage: 230 V
Rated current: 12.3 A
Rated power: 2600 W
Power output: 1870 W
Rated frequency: 50-60 Hz
No-load speed (1/min): 550 - 1070 - 1630
Drillability (mm): 125-250 / 60-130 / 40-80
Connection: 1"1/4 UNC
Ø drilling on concrete (mm): 40 -250
Speed: 3 mechanical
Weight: 11,9 kg
Other versions are also available on request



## SEM 32 MOTOR

### TECHNICAL DATA SHEET

Rated voltage: 230 V
Rated current: 15 A
Rated power: 3200 W
Power output: 2300 W
Rated frequency: 50-60 Hz
No-load speed (1/min): 420 - 820 - 1250
Drillability (mm): 165-350 / 80-160 / 55-105
Connection: 1"1/4 UNC
Ø drilling on concrete (mm): 55 -350
Speed: 3 mechanical
Weight: 11,9 kg
Other versions are also available on request



## SEM 32P MOTOR

**NEW**

### TECHNICAL DATA SHEET

Rated voltage: 230 V
Rated current: 15 A
Rated power: 3200 W
Power output: 2300 W
No-load speed (1/min): 420 - 820 - 1250
Drillability (mm): 165-350 / 80-160 / 55-105
Connection: 1"1/4 UNC
Ø drilling on concrete (mm): 50 -350
Speed: 3 mechanical
Weight: 12.4 Kg
Equipped with micropercussion



Micropercussion

## SEM 42 MOTOR

### TECHNICAL DATA SHEET

Rated voltage: 400/3V
Rated current: 7.2 A
Rated power: 3900 W
Power output: 3000 W
Rated frequency: 50-60 Hz
No-load speed (1/min): 160 - 340 - 510
Drillability (mm): 230-400 / 110-220 / 70-150
Connection: 1"1/4 UNC
Ø drilling on concrete (mm): 70 - 400
Speed: 3 mechanical
Weight: 19 Kg
Other versions are also available on request



# SEM 52 MOTOR



## TECHNICAL DATA SHEET

Rated voltage: 400 V
Rated current: 9.5 A
Rated power: 5200 W
Power output: 4000 W
Rated frequency: 50-60 Hz
No-load speed (1/min): 140 - 280 - 430
Drillability (mm): 320-500 / 160-320 / 110-210
Connection: 1"1/4 UNC
Ø drilling on concrete (mm): 110 - 500
Speed: 3 mechanical
Weight: 22,9 kg
Other versions are also available on request

# SSR25 MOTOR



## TECHNICAL DATA SHEET

Rated voltage: 230 V
Rated current: 16 A
Rated power: 3700 W
Power output: 2700 W
Rated frequency: 50-60 Hz
No-load speed (1/min): 230-280-340-410-490 570
Connection: 1"1/4 UNC
Ø drilling on concrete: 70 - 370
Speed: 6 electronic
Weight: 14.7 Kg

# SSR38 MOTOR



## TECHNICAL DATA SHEET

Rated voltage: 230 V
Rated current: 16 A
Rated power: 3700 W
Power output: 2700 W
Rated frequency: 50-60 Hz
Full speed (1/min)
Motor level 1: 180-220-260-320-380-440
Motor level 2: 360-430-520-630-755-880
Motor level 3: 560-670-810-980-1180-1370
Connection: 1"1/4 UNC
Ø drilling on concrete (mm): 40 - 400
Speed: 6 electronic and 3 manual. Spd.
Tot: 18
Weight: 16 Kg

# SSR65 MOTOR



## TECHNICAL DATA SHEET

Rated voltage: 400/3 V
Rated current: 15 A
Rated power: 7500 W
Power output: 5700 W
Rated frequency: 50-60 Hz
No-load speed (1/min): 140-175-205-240-270-305
Connection: 1"1/4 UNC
Ø drilling on concrete (mm): 120 - 500
Speed: 6 electronic
Weight: 18 kg

# SSR68 MOTOR



## TECHNICAL DATA SHEET

Rated voltage: 400/3 V
Rated current: 15 A
Rated power: 7500 W
Power output: 5700 W
Rated frequency: 50-60 Hz
Full speed (1/min):
Motor level 1: 205-245-290-340-400-450
Motor level 2: 410-480-570-670-790-880
Motor level 3: 640-750-880-1040-1230-1370
Connection: 1"1/4 UNC
Ø drilling on concrete (mm): 50 - 350
Speed: 6 electronic and 3 manual. Spd.
Tot: 18
Weight: 16 Kg

# SSR75 MOTOR



## TECHNICAL DATA SHEET

Rated voltage: 400/3 V
Rated current: 9.5 A
Rated power: 7500 W
Power output: 5700 W
Rated frequency: 50-60 Hz
Full speed (1/min):
Motor level 1: 60 - 70 - 85 - 100 - 115
Motor level 2: 115 - 140 - 165 - 200 - 230
Motor level 3: 180 - 215 - 260 - 310 - 360
Connection: 1"1/4 UNC
Ø drilling on concrete (mm): 150 - 950
Speed: 5 electronic and 3 manual. Spd. Tot: 15
Weight: 19,5 kg

# CORING ACCESSORIES

## CARRIAGE FOR CORE DRILL SEAPLATFORM

For floor drilling with core drills on columns.

Avoids floor anchoring of equipment and facilitates movement.



## WALL CLAMP SEAWALL

For securing SEADRILL 200 and SEADRILL 250 core drills on fence walls. Ideal for drilling a large number of holes in series, such as in fastening holes in palisades.

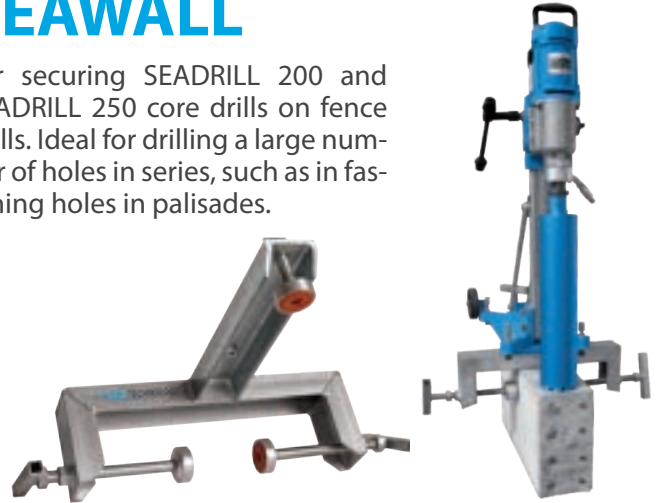

## SUCTION KIT WITH CASE SEADUST KIT

Practical and functional case containing everything you need for dust vacuuming. Includes M18 rotating head, two spanners 36 and 41, centring plates 112, 122, 127, 132, 142, 152, 162, 182, 205, 2 copper rings, a 200 mm long extension 1"1/4M-1"1/4 F, a 200 mm long 1/2 gas extension and the centring piston.



## WATER COLLECTOR COVER

The Water Collector is to be used on flat and even surfaces, when you need to recover the water used for cooling the tool. To be connected to a professional dust and liquid vacuum cleaner with a sufficiently large tank, e.g. the Aspiramax 50 L. For core bits up to a maximum diameter of 350 mm. When wet coring, this drastically limits water leakage. Ideal for coring in homes.



## VACUUM PUMP SEAVACUUM

It is a depressor for fixing core drills equipped with a suitable plate. Damage to the machining surface is avoided. For SEADRILL 200 and SEADRILL 250.



## PIPE CLAMP PPIPE

Drilling system suitable for pipes (stone-ware - concrete - spheroidal cast iron). Special features: attachment to round pipes without support up to DN 500; can generally be attached to DN 500 pipes using straps; only one crank handle per function (attachment of PIPEDRILL and motor); system can be used by a single person; easy to adjust.

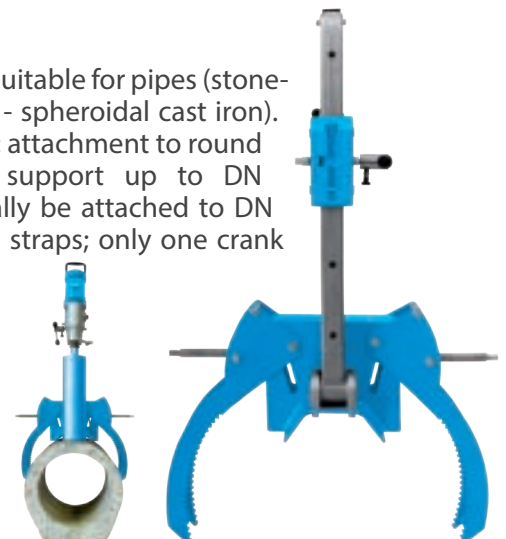

## CYLINDRICAL CENTRING BITS AND SDS

Cylindrical Centring Bits are available in two lengths: 220 mm for dry core bits length 150 mm and 270 mm for dry core bits length 200 mm.

SDS Centring Bits are available in two lengths: 230 mm for dry core bits length 150 mm and 260 mm for dry core bits length 200 mm.



## HEXAGONAL FITTINGS, SDS E SDS MAX

Made of high-grade steel suitable for high torsional stresses Hexagonal attachments are available in lengths 110, 220, 370 and 450 mm.

SDS couplings are available in lengths of 110, 220 and 370 mm. SDS Max couplings are available in lengths of 120 and 300 mm



## EXTENSIONS

All Extensions are made of high quality steel and suitable to withstand the high torsional stresses that are transmitted and concentrated in the fitting points. They are available in different lengths from 100 to 250 mm and in various thread combinations M16, M18, 5/8, 1"1/4 and 1/2 gas. Also available in hexagonal version 1.200-400 mm with 1"1/4 thread (for more information see price list).



## ADAPTERS AND QUICK ADAPTERS

Adapters made of high-strength steel, 50 mm long and with various thread combinations for mounting drills on most commercially available core drills.

Quick Adapters made from high quality steel for mounting and removing the SDS centring bit from the adapter with a click, making the operation quick and easy. Available with M16, M18, 5/8, 1/2 gas and hexagonal threads.



## CORE DRILL PLUGS AND BUSHINGS

The Anchor Bolts for Coring Machines are strong-holding plugs developed specifically for fixing column coring machines, with threading onto the plug M12 Female.

The Spare Bushings for Anchor bolts for Coring Machines have a M12 Male thread and are sold only in packs of 25 pieces.



## TOOL DRESSING STONE

The Tool Dressing Stone is a small brick made from highly abrasive material. It is used to restore the original sharpness to the tool, after this has lost its shine after many uses or when the material is particularly difficult to cut or drill.

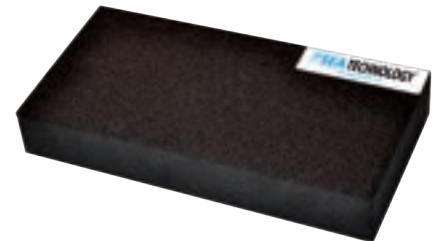

## CENTRING PISTON

The Centring Piston is the innovative centring system of the CORONA TRE 300 EXTRACTION. Suitable for diameters below 112, it maintains effective dust vacuuming even when inserted in the fitting, i.e. before drilling. The bayonet coupling makes it practical and easy to insert and remove. Remove it from the fitting as soon as the core bit has made the hole, i.e. 0.5/1 cm hole depth, to avoid damage and/or pointless stress.



## PORTABLE TANK

To be used where there is no handy water source at the construction site. 10 litre capacity. The water dispensing pressure is obtained manually.



## TANK WITH ELECTRIC PUMP

To be used where there is no handy water source at the construction site. 40 litre capacity. The pressure for the water supply is obtained through a small electric pump with a 12 V battery.





# CUTTING AND GRINDING ACCESSORIES

## SEACOVER T115-T125-T230



### TECHNICAL DATA SHEET

Weight T115: 0.3 kg - Weight T230: 0.6 Kg

Dimensions T115 (LxW xH): 200 x 110 x 40 mm

Dimensions T230 (LxW xH): 290 x 180 x 40 mm

Max. cutting depth with blade Ø 115: 17 mm

Max. cutting depth with blade Ø 230: 65 mm

Materials: powder-coated iron

## SLIDER T115 - T125



### TECHNICAL DATA SHEET

Weight: 0.5 Kg

Dimensions: 220 x 100 x 90 mm

Cutting depth: 0.1 mm to 17 mm

Materials: powder-coated iron and fluoroplastic

## JOLLY T115 - T125



### TECHNICAL DATA SHEET

Weight: 0.620 Kg

Dimensions: 320 x 100 x 125 mm

Cutting depth with blade Ø 115: 17 mm

Materials: powder-coated iron and fluoroplastic

## SEACOVER 82 and 162



### TECHNICAL DATA SHEET

Weight: 110 gr. (Ø 82 mm) - 190 g. (Ø 162 mm)

Hole size: 82 mm and 162 mm

Cover Dimensions Ø 82 (L x W x H) : 180 x 220 x 70 mm

Cover Dimensions Ø 162 (L x W x H) : 340 x 270 x 70 mm

Made of plastic

## CORE BIT CENTRING



### TECHNICAL DATA SHEET

Weight: 0.500 Kg

Dimensions: 210 x 95 x 125 mm

Materials: powder-coated iron and plastic and suction cup

Use: with core bits from Ø 6 to 68 mm

## SEACOVER L125 and L180



### TECHNICAL DATA SHEET

Weight: 1,450 Kg

Suction hose diameter: min 35 mm - max 51 mm

Dimensions (L x W x H): 250 x 180 x 80 mm

Materials: rubber, plastic, fluoroplastic, iron



# DUST SUCTION SYSTEM

## SEACLEAN 25/25M

Can be used for vacuuming both dust and of liquids, the 25-litre tank limits its use for work that requires limited use of water. The filter shaker is actuated automatically, i.e. it starts automatically and does not interrupt the action of the machine while cleaning the two filters. The machine comes complete with 4.5 m hose and the kit accessories including a set of tools to use the machine in various environments. Ideal for Seadrill 1800 and Seadrill 1800 Acqua and all SEA Technology power tools.

Also available in an M version (higher dust filtration capacity).



### TECHNICAL DATA SHEET

Power input: 1600 W - 230 V

Possibility of automatic ignition with power tool

2 Innovative design filters with total surface area 8600

cm<sup>2</sup> of dust retention as per BIA Cat.C

Automatic filter cleaning with electromagnetic pulse

Vacuum hose length 4.5 m

Electrical cable length 8 m  
Capacity: 25 l

Dimensions (LxWxH)mm 57x36x37  
Weight 12 kg

## SEACLEAN 50

Suitable for both dust and liquid intake, SEACLEAN 50 differs from SEACLEAN 25 by its tank capacity, which is 50 litres in this model, to better respond to drilling needs that require large volumes of water. The machine comes complete with 4.5 m hose and the kit accessories including a set of tools to use the machine in various environments. Ideal for Seadrill 200 and Seadrill 250.



### TECHNICAL DATA SHEET

Power input: 1600 W - 230 V

Possibility of automatic ignition with power tool

2 Innovative design filters with total surface area 8600

cm<sup>2</sup> of dust retention as per BIA Cat.C

Automatic filter cleaning with electromagnetic pulse

Vacuum hose length 4.5 m

Electrical cable length 8 m  
Capacity: 50 l

Dimensions (LxWxH)mm 58x47x64  
Weight 15 kg

# SEACLEAN 220 IC

The SEACLEAN 220 IC model is an extremely compact extractor, developed in line with market demands for increasingly efficient fine dust extraction, but at the same time manoeuvrable and transportable to any workplace thanks to its oversized rear wheels, without neglecting the robustness of an industrial extractor. The container release system allows easy emptying of the machines without the effort of disassembling the suction head.



## TECHNICAL DATA SHEET

<b>Power: 2200 W - Voltage: 230 V</b>	<b>Air flow rate: 340 m3/h</b>
<b>Frequency: 50 Hz</b>	<b>Max. depression 230 mBar</b>
<b>Motorisation: 2 by-passes</b>	<b>Capacity 20 litres</b>
<b>Automatic filter shaker</b>	<b>Dimensions (L x W x H): 54 x 58 x 85 cm</b>
<b>Hepa filtration class</b>	<b>Weight: 83 Kg</b>

# SEACLEAN 360

The vacuum unit is equipped with two Bypass motors that start sequentially once the power button is pressed, to avoid sudden current peaks. The filter unit consists of two elliptical cartridge filters. The filtering efficiency is guaranteed by an automatic and continuous cleaning system that, by means of a vibration, prevents dust from sticking to the cartridge. Continuous vibration cleaning is activated with the switch-on of the vacuum cleaner itself and remains throughout use. The operator can ensure an extra filter cleaning cycle by means of the manual DUSTOP system, or by means of a dedicated vibration in the absence of suction that shuts down the motors for 12 seconds, which can be activated by means of the dedicated button in the header. The vacuumed material is bladecharged into a 20 m long Endless Bag; when the end of the bag is full, the operator can seal the part to be disposed of and dispose of it safely, avoiding any contact with dust and its spread into the surrounding environment. Large surface filter, all-steel construction, two powerful by-pass motors with independent cooling, compact and mobile, height can be reduced for easy transport on vehicles, integrated automatic filter cleaning system, endless bag, accessory kit included.

**NEW**



## TECHNICAL DATA SHEET

<b>Power: 2 motors x 2.3 W each - 230 V - 50/60 Hz</b>	<b>Filter surface: 20,000 cm<sup>2</sup></b>
<b>Max. negative pressure: mm H<sup>2</sup>O: 2500</b>	<b>Vacuum Ø: 80</b>
<b>Air flow MAX m<sup>3</sup>/h 360</b>	<b>Vacuum hose length: 4.5 Mt</b>
<b>Noise dB (A) 76</b>	<b>Dimensions (H x W x L): 120 x 53 x 60 cm</b>
<b>Filter type: polyester L</b>	<b>Weight: 80 Kg</b>

# SEACLEAN 600

The focus of SEA Technology's engineers during the development of SEACLEAN 600 was on construction quality and vacuum power, in order to obtain a machine with a longer service life and suitable for the most wide variety of applications possible during intensive use. Designed to vacuum large quantities of dust in combination with machinery that produces intensive removal of cut or ground material, such as e.g. work on concrete floors, stone or marble. The ideal use is in connection with SEAGRIND 280 and SEAGRIND 550 grinding machines.



## TECHNICAL DATA SHEET

<b>Power: 3 motors x 1400 W each - 230 V - 50/60 Hz</b>	<b>Protection: IP 42</b>	<b>Weight: 125 Kg</b>
<b>Max. total power: 4800 W - 20 A</b>	<b>Max. negative pressure: mm H<sub>2</sub>O: 2450</b>	
<b>2 innovatively designed filters</b>	<b>Vacuum hose length: 4.5 Mt</b>	
<b>Capacity: Longpac with 30 notches for 25 kg each.</b>	<b>Dimensions (H x W x L): 130 x 140 x 70 cm</b>	
<b>Filtered surface: 14,000 cm<sup>2</sup></b>	<b>Hour meter: yes</b>	<b>Intake air: m3/h: 600</b>







# CUPS

## PLATO DIECI RESINA

This tool is designed with polycrystalline inserts to remove various types of materials that normally cause adhesion on traditional tools such as glues, paints, resins, sheaths, etc.



### TECHNICAL DATA SHEET

resins, sheaths		<b>SUPER</b>
adhesives, sealants		<b>EXCELLENT</b>
glues, paints		<b>GOOD</b>
		<b>MEDIUM</b>
		<b>SUFFICIENT</b>
		<b>INADEQUATE</b>

AVAILABLE  
Ø 125







## PLATO NOVE

The non plus ultra among diamond cups. To be mounted on electric grinders, this product is dedicated to the most demanding customers, who are not satisfied with a good product, but want only the best on the market. Super in performance and durability.



### TECHNICAL DATA SHEET

cured concrete, reinforced concrete, granite, porphyry, sandstone, natural stone		<b>SUPER</b>
bricks, tiles, gravel slabs		<b>EXCELLENT</b>
marble, refractory, double-fired, porcelain stoneware, single-fired		<b>GOOD</b>
		<b>MEDIUM</b>
		<b>SUFFICIENT</b>
fresh concrete, asphalt		<b>INADEQUATE</b>





AVAILABLE  
Ø 100 - 125



# PLATO SETTE RESINA

Cup suitable for roughing concrete surfaces, including resin surfaces. Thanks to the special shape of the segments, the tool allows easy removal of material, reducing the effort of the sanders or grinders on which it is mounted. It is equipped for dust extraction.



TECHNICAL DATA SHEET	
cement, resin floors	 SUPER
	 EXCELLENT
	 GOOD
	 MEDIUM
	 SUFFICIENT
	INADEQUATE





AVAILABLE  
Ø 125 - 150 - 180



# PLATO SETTE CEMENTO

Cup designed for the removal of any material, particularly cement. The high output allows large surfaces to be roughened, whether mounted on grinders or sanders with dust extraction thanks to the perforated steel.



TECHNICAL DATA SHEET	
	 SUPER
cured concrete, bricks, tiles, granite, natural stone, porphyry	 EXCELLENT
	 GOOD
reinforced concrete, marble, refractory, sandstone, gravel slabs	 MEDIUM
	 SUFFICIENT
	INADEQUATE





AVAILABLE  
Ø 125 - 150 - 180



# PLATO SEI FAST

Cup suitable for both grinders and sanders. The special shape and position of the holes between the segments allow for better dust extraction. The 'Z' shape of the segment significantly increases its speed and smoothness. For universal use in construction or specific use in stone.



TECHNICAL DATA SHEET	
cured concrete, bricks, tiles	 SUPER
	 EXCELLENT
lightly reinforced concrete, granite, natural stone, porphyry	 GOOD
refractory, sandstone, washed gravel slabs	 MEDIUM
marble, fresh concrete	 SUFFICIENT
double-fired, single-fired, asphalt, porcelain stoneware, klinker	INADEQUATE

AVAILABLE  
Ø 100 - 125  
150 - 180



# PLATO CINQUE STANDARD

Cup suitable for use on both electric grinders and suction Sanders, thanks to the perforated body that allows dust to pass through. The segmented design makes this tool very fast and aggressive and therefore more suitable for roughing rather than finishing work. The diamond sector protrudes from the steel body to allow flush machining.



## TECHNICAL DATA SHEET

		<b>SUPER</b>
cured concrete, bricks, tiles, granite, natural stone, porphyry		<b>EXCELLENT</b>
		<b>GOOD</b>
reinforced concrete, marble, refractory, sandstone, gravel slabs		<b>MEDIUM</b>
porcelain stoneware, klinker, fresh cement		<b>SUFFICIENT</b>
double-fired, single-fired, asphalt		<b>INADEQUATE</b>

AVAILABLE  
Ø 100 - 125  
150 - 180



# PLATO QUATTRO FAST

The scratchiest and most removing of the range. It combines two technologies: sintering and vacuum, giving PLATO QUATTRO FAST the medal as the product of choice for those seeking speed, strong removal and smoothness. Also good on certain types of resins and glues.



## TECHNICAL DATA SHEET

		<b>SUPER</b>
granite, natural stone, porphyry		<b>EXCELLENT</b>
cement, bricks, tiles		<b>GOOD</b>
		<b>MEDIUM</b>
lightly reinforced concrete, marble, refractory, sandstone, washed gravel slabs, porcelain stoneware, klinker		<b>SUFFICIENT</b>
heavily reinforced concrete, double-fired, single-fired, fresh concrete, asphalt		<b>INADEQUATE</b>

AVAILABLE  
Ø 125



# PLATO QUATTRO STANDARD

Thanks to the special 'S' shape of the segments, their symmetry and diagonal knurling, PLATO QUATTRO STANDARD stands out due to its speed and smoothness even in the hardest materials.



## TECHNICAL DATA SHEET

		<b>SUPER</b>
cured concrete, bricks, tiles, granite, natural stone, porphyry		<b>EXCELLENT</b>
		<b>GOOD</b>
reinforced concrete, marble, refractory, sandstone, washed gravel slabs		<b>MEDIUM</b>
porcelain stoneware, klinker, fresh cement		<b>SUFFICIENT</b>
double-fired, single-fired, asphalt		<b>INADEQUATE</b>

AVAILABLE  
Ø 125

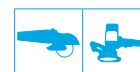

# PLATO TRE

PLATO TRE arose from the need to provide a product of the same quality as PLATO CINQUE but with less performance, making it ideal for those who do not use it on a daily basis. The perforated body allows dust extraction when the tool is used on sanding machines equipped with suction. For universal use in construction or specific use (marble, granite) in stone.



## TECHNICAL DATA SHEET



**SUPER**



**EXCELLENT**

cured concrete, bricks, tiles, granite, natural stone, porphyry



**GOOD**

lightly reinforced concrete, marble, refractory, sandstone, gravel slabs



**MEDIUM**

porcelain stoneware, klinker, fresh cement



**SUFFICIENT**

heavily reinforced concrete, double-fired, single-fired, asphalt

**INADEQUATE**

AVAILABLE  
Ø 100 - 125



# PLATO DUE

PLATO DUE with its 'arrow' design is designed to offer quick and easy sanding of different types of surfaces and offer an excellent price while maintaining quality standards in line with the products in the SEA Technology catalogue!



## TECHNICAL DATA SHEET



**SUPER**



**EXCELLENT**

cured concrete, bricks, tiles, granite, natural stone,



**GOOD**

lightly reinforced concrete, marble, refractory, sandstone, gravel slabs



**MEDIUM**

porcelain stoneware, klinker, fresh cement



**SUFFICIENT**

heavily reinforced concrete, double-fired, single-fired, asphalt

**INADEQUATE**

AVAILABLE  
Ø 100 - 125  
150 - 180

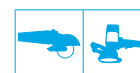

# DIAMOND MODULES GRINDING AND POLISHING

## GRINDER YELLOW PCD

FOR REMOVING RESINS AND THICK COATINGS. Grinder Yellow PCD is manufactured with two polycrystalline PCD inserts plus a diamond sector. This module quickly removes all types of elastic coatings such as paint, glue, epoxy resin, acrylic, screed residues, adhesive tar and elastic material. Do not use on fresh concrete or abrasive floors. Very resistant even on abrasive floors. It leaves the surface regularly scratched.



### TECHNICAL DATA SHEET

paint, glue, epoxy resin, acrylic, screed residues, adhesive tar and elastic material, concrete floors, uneven and abrasive	★★★★★	<b>SUPER</b>
	★★★★	<b>EXCELLENT</b>
	★★★	<b>GOOD</b>
	★★	<b>MEDIUM</b>
	★	<b>SUFFICIENT</b>
fresh concrete, abrasive floors		<b>INADEQUATE</b>
Module for sanding elastic materials	PCD machining	Grit 6-10



## GRINDER YELLOW

SUITABLE FOR THE PREPARATION AND REMOVAL OF COATINGS ON ELASTIC CONCRETE FLOORS. Modules with BKS TECHNOLOGY diamond segments, extremely hard and aggressive. It quickly removes undulations, mastics, paints, film and epoxy resins, self-levelling agents and various coatings on abrasive concrete floors. Recommended for levelling and preparing soft concrete and abrasive floors. They guarantee high durability.



### TECHNICAL DATA SHEET

soft, abrasive cement	★★★★★	<b>SUPER</b>
corrugations, mastics, paints, film and epoxy resins	★★★★	<b>EXCELLENT</b>
	★★★	<b>GOOD</b>
	★★	<b>MEDIUM</b>
	★	<b>SUFFICIENT</b>
		<b>INADEQUATE</b>
Module for sanding aggressive materials	Rough machining	Grit 6-10





# GRINDER FOR SANDERS

Sander grinders are modules developed for sanding concrete floors and are available in various qualities for various cements, from the hardest to the softest. Also available in 3 processing types: coarse, semi-fine and fine and in the following grits: 16-18, 30-40, 60-80, 80-100 and 120-140. For use with the professional grinders SEAGRIND 280 and SEAGRIND 550.



SEAGRIND 280

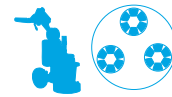

SEAGRIND 550

## GOLD CEMENT VERY HARD



Rough Machining

Grit 16-18



Rough Machining

Grit 30-40



Semi-fine machining

Grit 60-80



Semi-fine machining

Grit 80-100



Fine machining

Grit 120-140

## GREEN CEMENT HARD



Rough Machining

Grit 16-18



Rough Machining

Grit 30-40



Semi-fine machining

Grit 60-80



Semi-fine machining

Grit 80-100



Fine machining

Grit 120-140

## BLUE CEMENT OF MEDIUM HARDNESS



Rough Machining

Grit 16-18



Rough Machining

Grit 30-40



Semi-fine machining

Grit 60-80



Semi-fine machining

Grit 80-100



Fine machining

Grit 120-140

## SILVER CEMENT ABRASIVE



Rough Machining

Grit 16-18



Rough Machining

Grit 30-40



Semi-fine machining

Grit 60-80



Semi-fine machining

Grit 80-100



Fine machining

Grit 120-140

## BLACK CEMENT VERY ABRASIVE



Rough Machining

Grit 16-18



Rough Machining

Grit 30-40



Semi-fine machining

Grit 60-80



Semi-fine machining

Grit 80-100



Fine machining

Grit 120-140

# SURFACE REMOVAL MACHINES

## SEAPRECUT 180

SEAPRECUT 180 is a surface cutter specially designed for cutting wood. Indispensable for the renovation of parquet floors, it is recommended for use in the pre-cutting phase of the wood, prior to removal of the parquet, which can be done with either Seastripper 100 or SEASTRIPPER 200. Equipped with an aluminium frame, SEAPRECUT 180 is particularly light, yet incredibly stable and fast. Ergonomic and usable in a standing position by the operator, SEAPRECUT 180 is simple and safe, thanks to the blade lowering system, which is adjustable from 0 to 22 mm and is prepared for dust extraction systems and processing residues. Its characteristics and low weight of 31 kg make it remarkably agile and quick to remove parquet flooring. It mounts a  $\varnothing$  180 mm blade that works up to a depth of 22 mm.

### TECHNICAL DATA SHEET

 **Operating motor:**  
single-phase electric 230V 2.2 kW

 **Blade:**  $\varnothing$  180 mm

 **Blade speed:** 4000 rpm.

 **Cutting depth:** 1- 22 mm

 **Dimensions (HxWxL)** 950 x 280 x 500 mm

 **Weight** 31 kg



NEW



## SEASTRIPPER 15

SEASTRIPPER 15 is a manual scraper developed for the removal of existing pavements, equipped with an ergonomic handle to allow the operator to work comfortably while standing.

It is 2-in-1, for use on both medium and small surfaces. It can therefore be used for removing materials in corners or for trimming flush areas and skirting boards, also in combination with Seastripper 100 AND SEASTRIPPER 200. Three different types of blades are available, with dimensions of 60 x 210 mm, each suitable for a different material to be removed: the steel blade for universal use, the hardened steel blade, 1.5 mm thick, suitable for heavy-duty work, and finally the blade with a 'U' design for cutting soft floors, such as carpet, PVC and linoleum. SEASTRIPPER 15 is powered by a single-phase 2200 W motor. The total weight is 14.5 kg.

### TECHNICAL DATA SHEET

 **Operating motor:**  
single-phase electric 230V 2.2 kW

 **Maximum working width:** 210 mm

 **Dimensions (W with handle x D x L):**  
135 x 21 x 106 cm

 **Two types of interchangeable blades**

 **Weight** 14.3 kg



NEW



# SEASTRIPPER 100

SEASTRIPPER 100 is a scraper with automatic feed, unique in its kind: thanks to the oscillating movement it is able to remove surfaces by acting laterally. SEASTRIPPER 100 is suitable for the removal of carpet, linoleum, vinyl and PVC. By adding the practical quick-connect ballasts, it is possible to increase the machine's original weight of 95 kg by up to 4 additional elements of 6 kg each, resulting in a total weight of 123 kg, which is optimal for the removal of particularly difficult surfaces such as parquet. SEASTRIPPER 100 is very practical in sites where no lifting gear is available, as the motor can easily be transported separately from the chassis to the required working point by a single operator, thanks to the convenient handles provided. It is powered by two single-phase electric motors of 750 W and 1.100 W.



## TECHNICAL DATA SHEET

<b>Motor advancement:</b> single-phase electric 230V 0.75 kW	<b>Strokes 2800 / bpm</b>
<b>Operating motor:</b> single-phase electric 230V 1.1 kW	<b>Dimensions (HxWxL) 640x1080x305 mm</b>
<b>Torque 145 Nm</b>	<b>Weight 95 kg (excluding additional ballast)</b>

# SEASTRIPPER 200

SEASTRIPPER 200 is a unique scraper with automatic feed: it removes surfaces by intermittent frontal and lateral vibration. It is suitable for the removal of carpets, linoleum, vinyl, PVC, ceramics, klinker, parquet.

By adding the practical quick-connect ballasts, the machine's original weight can be increased to 248 kg, the optimum weight for removing particularly difficult surfaces such as parquet. SEASTRIPPER 200 is unique in that it uses a single-phase power supply for its operation, which makes it also suitable for use in the civil sector. In addition, it is equipped with an inverter that converts the current from single-phase to three-phase, thus benefiting from a higher torque, which makes it exceptional for the removal of klinker and parquet floors. The rubberised tracks also make it an inimitable machine for its high 'grip' when moving forward.



## TECHNICAL DATA SHEET

<b>Motor advancement:</b> single-phase electric 230V 1.50 kW	<b>Motion wheel included</b>
<b>Operating motor:</b> single-phase electric 230V 1.1 kW	<b>Dimensions (HxWxL) 760x1100x380 mm</b>
<b>Torque 327 Nm - Strokes 2500 / bpm</b>	<b>Weight 195 kg (excluding additional ballast)</b>

# ACCESSORIES FOR SCRAPERS

Wide range of blades and chisels for the removal of Carpet, Vinyl Flooring, Linoleum, PVC, Parquet, Ceramic Tiles, Clinker Tiles. All accessories are manufactured from hardened steel in order to increase their service life.

## TECHNICAL DATA SHEET

- Blade for carpet and linoleum (see table)**
- Blade for carpet and linoleum flat profile (see table)**
- Blade for ceramics, stoneware and klinker**



Additional weights are available for Seastripper 200 and Seastripper 100.

# ACCESSORIES FOR SCRAPERS: FULL RANGE

## APPLICATION TABLE FOR BLADES AND CHISELS

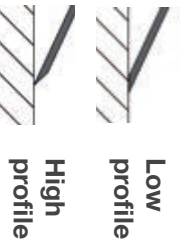

**Low profile**

**High profile**

### Warnings

A narrow blade will always be more efficient than a wider blade. If you realise that with a narrow blade you are scraping very easily, you can then switch to the larger size to increase area performance.

Floor cut width = Blade width.

SEA Technology has chosen to offer only U-Blades for better steel quality. The V-blade is cheaper, you cannot bend it to a U and it is less effective

		Carpet	Vinyl/LVT	Carpet Felt	Studded rubber/plastic flooring	Linoleum	PVC	Vinyl Cushioned	Parquet / solid wood	Parquet/ wood 2/3-layers glued elastic	Parquet / wood 2/3-layer HDF or MDF	Ceramic tiles
<b>SEASTRIPPER 15</b>												
210x60x0,8mm flat item no.: SEASTR714580		***	***	***	***	***	***	***	***	***	***	***
210x60x1,5mm flat item no.: SEASTR714581		*****	*****	*****	*****	*****	*****	*****	*****	*****	*****	*****
210x60x0,8mm, high profile item no.: SEASTR714592		**	*	**	*	*	**	***				
<b>medium performance m<sup>2</sup>/h with MSTR15</b>		<b>18</b>	<b>15</b>	<b>20</b>	<b>12</b>	<b>15</b>	<b>20</b>	<b>25</b>				
<b>SEASTRIPPER 100 / SEASTRIPPER 200</b>												
150 x 80 x 2 mm U-blade, high profile item no.: SEASTR719615		*****	*****	*****	*****	*****	*****	*****	*****	*****	*****	*****
150 x 80 x 2 mm U-blade, low profile item no.: SEASTR719616		*****	*****	*****	*****	*****	*****	*****	*****	*****	*****	*****
200 x 80 x 2 mm flat item no.: SEASTR719620		*****	*****	*****	*****	*****	*****	*****	*****	*****	*****	*****
200 x 80 x 2 mm U-blade, high profile item no.: SEASTR719640		*****	*****	*****	*****	*****	*****	*****	*****	*****	*****	*****
200 x 80 x 2 mm U-blade, low profile item no.: SEASTR719645		*****	*****	*****	*****	*****	*****	*****	*****	*****	*****	*****
250 x 80 x 2 mm flat item no.: SEASTR718400		***	***	***	***	***	***	***	***	***	***	***
250 x 60 x 2 mm U-blade, low profile item no.: SEASTR718520		***	***	***	***	***	***	***	***	***	***	***
250 x 80 x 2 mm U-blade, high profile item no.: SEASTR718430		***	***	***	***	***	***	***	***	***	***	***
250x80x2 mm U-blade, low profile item no.: SEASTR718440		***	***	***	***	***	***	***	***	***	***	***
350 x 80 x 2 mm flat item no.: SEASTR718420		*	*	*	*	*	*	*	*	*	*	*
350 x 80 x 2 mm U-blade, high profile item no.: SEASTR718450		*	*	*	*	*	*	*	*	*	*	*
350 x 80 x 2 mm U-blade, low profile item no.: SEASTR718460		*	*	*	*	*	*	*	*	*	*	*
100mm width (narrow angle) item no.: SEASTR718596		*****	*****	*****	*****	*****	*****	*****	*****	*****	*****	*****
120mm width (narrow angle) item no.: SEASTR718598		*****	*****	*****	*****	*****	*****	*****	*****	*****	*****	*****
250 x 18 x 6 mm (wood, tiles - medium angle) item no.: SEASTR718589		***	***	***	***	***	***	***	***	***	***	***
<b>SEASTRIPPER 200</b>												
<b>medium performance m<sup>2</sup>/h with MSTR100</b>		<b>60</b>	<b>60</b>	<b>50</b>	<b>40</b>	<b>50</b>	<b>70</b>	<b>80</b>				
<b>medium performance m<sup>2</sup>/h with MSTR200</b>		<b>40</b>	<b>40</b>	<b>30</b>	<b>25</b>	<b>30</b>	<b>50</b>	<b>65</b>	<b>20</b>	<b>8</b>	<b>6</b>	<b>10</b>

# SURFACE PREPARATION MACHINES

## SEASCAR 200/265

SEASCAR 200 is a lightweight milling machine suitable for small to medium surfaces. The machine's low centre of gravity allows rapid and uniform milling. The machine can be used with either the tiller roller or the bush roller. SEASCAR 200 was designed especially for milling asphalt, concrete, stone, floor tiles, cement screed, screeds, paints, etc. for milling surfaces of the required height or for removing excess or degraded layers. Equipped with a side lever that allows the machine to be moved without losing the previous adjustment. Also available with a 265 mm wide roller.

### TECHNICAL DATA SHEET

 Power input: 2200 W - 230 V

 Speed: 1925 rpm spindle / 2750 rpm motor

 8 points with anti-vibration bearings from the handle and motor

 Roller width: 200 mm / 265 mm

 Tool depth: 1-5 mm

 Dimensions (LxWxH) 1000 x 955 x 400 mm

 Weight 77 kg



## SEAGRIND 125

SEAGRIND 125 differs from other grinders on the market in that it has a mechanical clutch combined with a power-stabilising electronic board. Appreciated by flooring contractors for its shaped casing that allows it to work flush with the wall and for its provision for a dust extractor. Powerful, thanks to its 1800 watt motor, it comes in a convenient metal box complete with sanding cup mod. PLATO 5 diam. 125 F. 22.2 mm.

### TECHNICAL DATA SHEET

 Power input: 1600 W - 230 V

 Cup Diameter: 125 mm

 Speed: 10,000 rpm sanding cup / 20,000 rpm motor

 Mechanical safety clutch

 Digital Electronic System

 Electronic overload control

 Connection: thread hole 22.2 mm

 Adjustable sanding depth: 0-7 mm

 Supplied with: metal case, cup and spanner











 Weight 4.6 kg



# SEAGRIND 280

SEAGRIND 280 is the ideal grinder for applications in areas of medium size without sacrificing performance, in terms of processing time per square metre. SEA Technology engineers have thus developed its compactness and user-friendliness without detracting from its power and technical operational solutions. Powerful and manoeuvrable, it has a double adjustable and foldable handle. With a shock absorbing system to reduce vibrations transmitted to the operator, the casing is equipped with accessories to create the left and right flush wall. With these features, SEAGRIND 280 becomes the standard setting machine in the small compact grinding machine sector.

## TECHNICAL DATA SHEET











 <b>Power input:</b> 2400 W - 230 V - 50/60 Hz - 14 A	 <b>Protection:</b> IP 55
 <b>Flat diameter:</b> 280 mm	 <b>Weight:</b> 53 Kg
 <b>Speed:</b> 1400 RPM	 <b>Dimensions (H x W x L):</b> 118 x 62 x 40 cm
 <b>Module coupling:</b> quick fitting	 <b>Hour meter:</b> yes
 <b>Transmission:</b> gear-driven	 <b>Flush with wall:</b> yes, left and right



# SEAGRIND 550

SEAGRIND 550 is a large grinding machine, designed by SEA Technology engineers for medium and large surfaces to be sanded. The strengths are the power of 3000 W which allows SEAGRIND 550 to work with 3 tool holder satellites and the possibility of dry grinding floors, as well as wet for final polishing. The rotary motion to the cups is transmitted via gears rather than toothed belts. Orbital rotation is selectable, with clockwise or anticlockwise direction reversal. The tilting main plate simplifies the operator's work on uneven surfaces. Equipped with a double adjustable and foldable arm.

## TECHNICAL DATA SHEET











 <b>Power input:</b> 3000 W - 230 V - 50/60 Hz - 16 A	 <b>Protection:</b> IP 54
 <b>Flat diameter:</b> 550 mm	 <b>Weight:</b> 140 Kg
 <b>Speed:</b> 1720 RPM	 <b>Dimensions (H x W x L):</b> 130 x 115 x 60 cm
 <b>Module coupling:</b> quick fitting	 <b>Hour meter:</b> yes
 <b>Transmission:</b> gear-driven	 <b>Rotorbitance:</b> adjustable



# SEAPOLISH 480

SEAPOLISH 480 is the new robust and reliable multi-purpose sander and polisher with gear drive. The 510 mm working surface makes SEAPOLISH 480 extremely performant on large areas and industrial floors, for renovations and demanding cleaning operations. The special feature of this machine is undoubtedly its versatility: thanks to a range of more than 50 accessories, SEAPOLISH 480 can be used for many different purposes, including polishing stone and similar materials, smoothing fresh concrete, sanding indoor and outdoor surfaces for subsequent treatment with epoxy or solvent formulations (non-slip, dustproof, water-repellent, scratchproof and mark-proof) in industrial environments and warehouses, but also homes, courtyards, car parks or shopping centres.

## TECHNICAL DATA SHEET

 <b>Drive:</b> mechanical	 <b>Torque:</b> 110 Nm
 <b>Power:</b> 230 V - 2300 W	 <b>Dimensions:</b> 64 x 48 x 138 cm
 <b>Frequency:</b> 50 Hz	 <b>Length of the guide bar:</b> 930 mm
 <b>Work surface:</b> 510 mm	 <b>Noise:</b> 62 dB (A)
 <b>Speed:</b> 156 rpm	 <b>Operating weight:</b> 58.5 kg (can be increased to 80.5 kg)



# COMPACTION













## SEARAMMER 80

Clay and silt are the hardest types of soil, and working them requires strength and speed of compaction. SEARAMMER 80 is the optimal choice in such terrain, thanks to the powerful Honda GXR120 motor with which it is equipped. Easy to handle and use, it guarantees excellent results, combining strength and speed.



### TECHNICAL DATA SHEET











 Engine type: petrol HONDA GXR120 - 2.3 kW - 3.1 HP	 Compaction depth: 0.50 - 0.70 m
 Base plate dimensions (WxL): 340 x 285 mm	 Advancement speed: 15 - 20 m
 Centrifugal force: 13.8 kN	 Sound emission level: 108 dB
 Stroke: 40- 85 mm	 Dimensions (DxLxH): 703 x 345 x 1028 mm
 Strokes per minute: 600 - 700	 Weight: 74 kg

## SEARAMMER 80D

Clay and silt are the hardest types of soil, and working them requires strength and speed of compaction. SEARAMMER 80D is the optimal choice in such terrain, thanks to its powerful YANMAR L48 Diesel motor. Easy to handle and use, it guarantees excellent results, combining strength and speed.

















### TECHNICAL DATA SHEET

 Engine type: YANMAR L 48 Diesel - 3.5 kW - 4.8 HP	 Compaction depth: 0.50 - 0.70 m
 Base plate dimensions (WxL): 340 x 285 mm	 Advancement speed: 15 - 20 m
 Centrifugal force: 18 kN	 Sound emission level: 108 dB
 Stroke: 40- 85 mm	 Dimensions (DxLxH): 703 x 410 x 1040 mm
 Strokes per minute: 600 - 700	 Weight: 85 kg

# SEAPLATE 12/60

Small in the range, SEAPLATE 12/60 is characterised by excellent handling due to its low weight and small size. Equipped with a Honda GX 120 engine, it is easily transportable and particularly suitable for use in confined spaces and for work requiring precision and agility. Easy to transport thanks to its wheels and folding handle.

## TECHNICAL DATA SHEET















 Centrifugal force 12 Kn	 Vibration frequency 92 Hz
 Plate width 330 mm	 Max speed 3 Mt/Min
 Plate length 450 mm	 Max. slope 40%
 Honda GX120 K 1 green petrol engine	 Dimensions (LxWxH) 710x310x850 mm
 Motor power 2.6 kW/3.5 hp	 Equipped with hour meter
 3600 rpm	 Wheel kit included
 Static surface pressure 0.067 Kg/cm <sup>2</sup>	 Water tank included    Weight: 67 Kg



# SEAPLATE 18/95

Thanks to its Honda GX 160 motor, synonymous with reliability, and its considerable centrifugal force, SEAPLATE 18/95 can compact both asphalt and gravel. Perfect for hire thanks to the sturdy, large steel plate and the ease of transport allowed by the folding handle.

## TECHNICAL DATA SHEET













 Centrifugal force 18 Kn	 Max speed 25 Mt/Min
 Plate width 450 mm	 Max. slope 30%
 Plate length 565 mm	 Dimensions (LxWxH) 500x580x765 (910 open) mm
 Honda GX160 K 1 green petrol motor	 Equipped with hour meter
 Motor power 4.0 kW/5.0 hp	 Water tank included
 3600 rpm	 Wheel kit included
 Static surface pressure 0.067 Kg/cm <sup>2</sup>	 Weight: 95 Kg
 Vibration frequency 100 Hz	



# SEAPLATE 24/115

SEAPLATE 24/115 with its Honda GX 160 motor, which is synonymous with reliability, and its considerable centrifugal force allows it to compact both asphalt and gravel. Perfect for hire thanks to the sturdy, large steel plate and the ease of transport allowed by the folding handle.

## TECHNICAL DATA SHEET

 Centrifugal force 24 Kn	 Max speed 25 Mt/Min
 Plate width 500 mm	 Max. slope 30%
 Plate length 565 mm	 Dimensions (LxWxH) 500x580x765 (910 open) mm
 Honda GX160 K 1 green petrol motor	 Water tank included
 Motor power 3.6 kW/5.0 hp	 Wheel kit included - Equipped with hour meter
 Rpm 3600 MIN <sup>-1</sup>	 Weight 115 kg
 Vibration frequency 100 Hz	



















# SEAPLATE 22/140

SEAPLATE 22/140 is the highest performing in the range of forward-facing plates. Thanks to its conformation, it is suitable for compacting gravel and compacted material. Thanks to the optional water kit and rubber mat, it can also be used on asphalt and self-locking pavements. SEAPLATE 22/140 is excellent for rental due to its robustness and ease of transport thanks to its folding handle and wheeled carriage.

## TECHNICAL DATA SHEET















 Centrifugal force 22 Kn	 Vibration frequency 81 Hz
 Plate width 450 mm	 Max speed 24 Mt/Min
 Plate length 610 mm	 Max. slope 30%
 Honda GX160 green petrol engine	 Dimensions (LxWxH) 730x450x638 mm
 Motor power 3.6 kW/4.9 hp	 Equipped with hour meter
 3600 rpm	 Wheel kit included
 Static surface pressure 0.067 Kg/cm <sup>2</sup>	 Weight: 140 Kg



# SEAPLATE 20/95 REVERSIBLE

SEAPLATE 20/95 R with its Honda GX 120 petrol motor, which is synonymous with reliability, and its considerable centrifugal force of 20 kN allows it to compact gravel and compacted material. Perfect for hire thanks to the sturdy, large steel plate and the ease of transport allowed by the folding handle.

## TECHNICAL DATA SHEET













 Centrifugal force 20 Kn	 Vibration frequency 100 Hz
 Plate width 350 mm	 Max speed 3 Mt/Min
 Plate length 526 mm	 Max. slope 30%
 Honda GX120 engine fuelled with green petrol	 Dimensions (LxWxH) 350x562x645 mm
 Motor power 2.6 kW/3.5 hp	 Equipped with hour meter
 3600 rpm	 Wheel kit not included
 Static surface pressure 0.067 Kg/cm <sup>2</sup>	 Water tank included    Weight: 95 Kg



# SEAPLATE 26/160 REVERSIBLE

Powerful compaction machines, particularly suitable for soil compaction. Alternatively, it can also be used for compacting asphalt or floor layers (especially for reversible slabs up to 250 kg). A modern style combined with a high compaction effect and a protective frame make it a robust and essential machine. Equipped with an accelerator lever on the handle, smooth travel speed control as well as a hydraulic stroke control system; advanced hydraulic system with automatic deaeration and adjustment. On request it is possible to have a water distribution kit for compacting the asphalt, a mat for the self-blockers and a wheel kit for easy handling on site. Available in both a petrol version with Honda motor and a diesel version with Hatz motor.

## TECHNICAL DATA SHEET













 Centrifugal force 26 Kn	 Static surface pressure 0.067 Kg/cm <sup>2</sup>
 Plate width 400 mm	 Vibration frequency 95 Hz
 Plate length 700 mm	 Max. speed 22 Mt/Min - Max. slope 30%.
 Honda GX200 green petrol engine	 Dimensions (LxWxH) 1000x400x630 mm
 Motor power 4.1 kW/5.5 hp	 Equipped with hour meter
 3600 rpm	 Wheel kit excluded - Weight: 160 kg



## SEAPLATE 32/210 REVERSIBLE

Powerful compaction machines, particularly suitable for soil compaction. Alternatively, it can also be used for compacting asphalt or floor layers (especially for reversible slabs up to 250 kg). A modern style combined with a high compaction effect and a protective frame make it a robust and essential machine. Equipped with an accelerator lever on the handle, smooth travel speed control as well as a hydraulic stroke control system; advanced hydraulic system with automatic deaeration and adjustment. On request it is possible to have a water distribution kit for compacting the asphalt, a mat for the self-blockers and a wheel kit for easy handling on site. Available in both a petrol version with Honda motor and a diesel version with Hatz motor.

### TECHNICAL DATA SHEET













 Centrifugal force 32 Kn	 Static surface pressure 0.067 Kg/cm <sup>2</sup>
 Plate width 500 mm	 Vibration frequency 90 Hz
 Plate length 750 mm	 Max. speed 22 Mt/Min - Max. slope 30%.
 Honda GX200 green petrol engine	 Dimensions (LxWxH) 1040x500x750 mm
 Motor power 3.6 kW/4.9 hp	 Equipped with hour meter
 3600 rpm	 Wheel kit excluded - Weight: 210 kg



## SEAPLATE 42/250 REVERSIBLE

The new reversible vibratory plate model bridges the gap between models weighing between 200 and 330 kg. This machine has a simple but effective construction, equipped with the tried and tested Honda GX 270 engine. The development of this new model focused mainly on the ergonomics of machine control, easy maintenance and our customers' experience in using these machines. SEAPLATE 42/250 R has easily adjustable forward and reverse speed control, and 'on the spot' compaction is also possible in the case of hard materials. The hydraulic feed control system is equipped with automatic deaeration and 'neutral' position setting. A removable stroke control kit, a mat for compacting asphalt pavement and a spray kit for compacting asphalt are available as options.

### TECHNICAL DATA SHEET

 Centrifugal force 42 Kn	 Static surface pressure 0.067 Kg/cm <sup>2</sup>
 Plate width 550 mm	 Vibration frequency 80 Hz
 Plate length 800 mm	 Max. speed 25 Mt/Min - Max. slope 30%.
 Honda GX270 green petrol engine	 Dimensions (LxWxH) 1100x550x800 mm
 Motor power 6.3 kW/8.4 hp	 Equipped with hour meter
 3600 rpm	 Wheel kit excluded - Weight: 280 kg



# CONTROLLED DEMOLITION

## TAGLIOMURO DIECI

TAGLIOMURO DIECI stems from the evolution of TAGLIOMURO OTTO SEA3D. The controlled demolition sector is evolving rapidly, the use of wall cutting machines with High-Frequency technology now accounts for almost the entire market, hence the need for the development of the Tagliomuro Dieci, a blade developed for best performance on high-frequency machines between 14 and 22 kW.

Available in thicknesses 4.2 - 4.7 up to Ø 908 mm.

Available in 4.4 thickness from Ø 1014 mm to Ø 1606 mm.

### TECHNICAL DATA SHEET

reinforced concrete



H 12 mm

AVAILABLE Ø  
614 - 664 - 714 - 814 - 829 - 908 -  
1014 - 1208 - 1306 - 1406 - 1506  
- 1606



# TAGLIOMURO OTTO SEA3D

The TAGLIOMURO OTTO SEA3D was born from the evolution of the TAGLIOMURO CINQUE. This tool is in fact produced using SEA3D technology, i.e. the three-dimensional positioning of the diamond during sintering. This allows absolute product consistency in both cutting speed and output, which in this tool are top notch. Suitable for any type of wall-cutting machine.

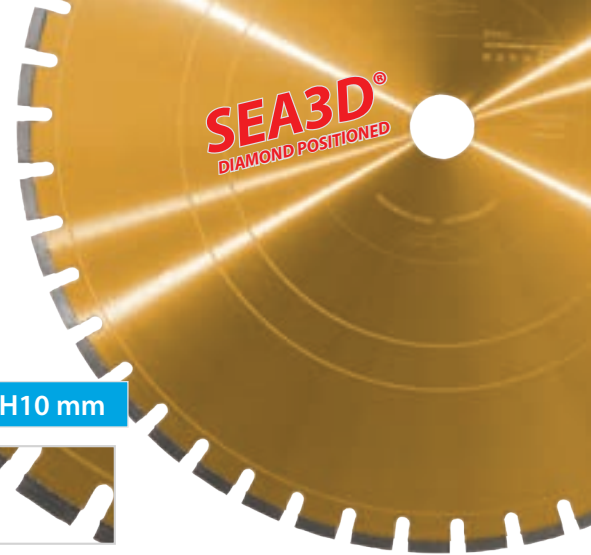

H10 mm



**AVAILABLE**  
 Ø 600 - 650 - 700 - 800 - 825  
 900 - 1000 - 1050 - 1200 - 1400  
 thicknesses 4.4 and 4.8



## TECHNICAL DATA SHEET

reinforced concrete	★★★★★
	★★★★
	★★★
	★★
	★

# TAGLIOMURO CINQUE

TAGLIOMURO CINQUE is a laser-welded demolition blade designed for wall-cutting machines with a power output of more than 15 kw. The special features of this tool are its high output combined with remarkable speed, even in heavily reinforced concrete. This performance comes from the special segment design and the sintering of the diamond with 2D technology (technology that allows two-dimensional positioning of the diamond during sintering).

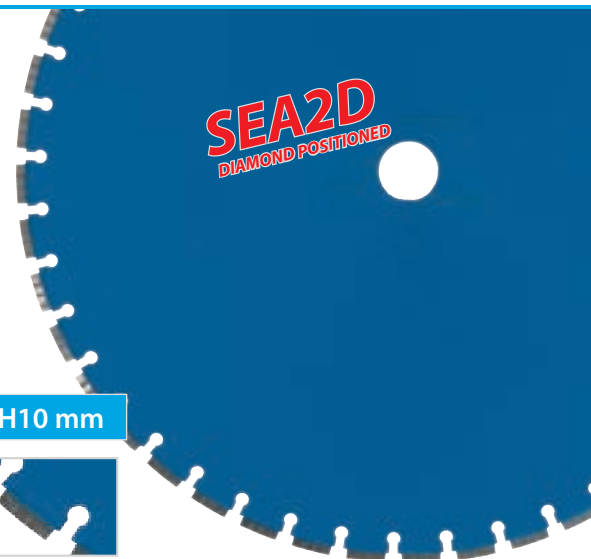

H10 mm



**AVAILABLE**  
 Ø 600 - 650 - 700 - 800 - 825 - 900  
 1000 - 1050 - 1200 - 1400 - 1600  
 thicknesses 4.4 and 4.8



## TECHNICAL DATA SHEET

reinforced concrete	★★★★★
	★★★★
	★★★
	★★
	★

# DIAMOND SINTERED WIRE

Sintered wire is a product that guarantees excellent performance in cutting speed combined with good yield. It is also produced on request in the SEA3d (positioned diamond) version, which guarantees 5% more yield and 25% higher speed than conventional sintered wire.



## TECHNICAL DATA SHEET

reinforced concrete	★★★★★	<b>SUPER</b>
	★★★★	<b>EXCELLENT</b>
	★★★	<b>GOOD</b>
	★★	<b>MEDIUM</b>
	★	<b>SUFFICIENT</b>
		<b>INADEQUATE</b>

## TECHNICAL DATA

SPESSORE Thickness	PERLE/METRO beads/meter
10.5 sintered	40

# ELECTROPLATED DIAMOND WIRE

Electroplated diamond wire is a product that guarantees excellent cutting speed combined with good performance and value for money. Also available in a conical bead version for cutting building materials as well as metals.



TECHNICAL DATA SHEET	
	<b>SUPER</b>
reinforced concrete	<b>EXCELLENT</b>
	<b>GOOD</b>
	<b>MEDIUM</b>
	<b>SUFFICIENT</b>
	<b>INADEQUATE</b>

TECHNICAL DATA	
SPESSORE Thickness	PERLE/METRO beads/meter
10 electroplated	40 cylindrical
10 electroplated	40 conical
10 electroplated	40 iron cone



# DIAMOND BLADE FOR GROOVES CONCRETE/ASPHALT

Diamond blade with increased segment thickness, designed for cutting tracks for the positioning of electrical cables, fibre optics, electrical circuits, etc. They can also be used in applications for opening, recovering or widening existing expansion joints. Suitable for use on soil cutting machines with a power rating of 13 hp and above. Available from thickness 6 to thickness 20 in various diameters.



TECHNICAL DATA SHEET	
asphalt	<b>SUPER</b>
concrete	<b>EXCELLENT</b>
	<b>GOOD</b>
	<b>MEDIUM</b>
	<b>SUFFICIENT</b>
	<b>INADEQUATE</b>



Ø and thicknesses on request



# TAGLIO PREFABBRICATO DIECI

This is the reference blade for cutting hollow core slabs. To meet the needs of the market, various binders have been studied, in order to satisfy the needs of the various producers. The tools are produced after a careful analysis of the aggregates and parameters of the machines on which they are mounted, making it possible to produce a customised tool.

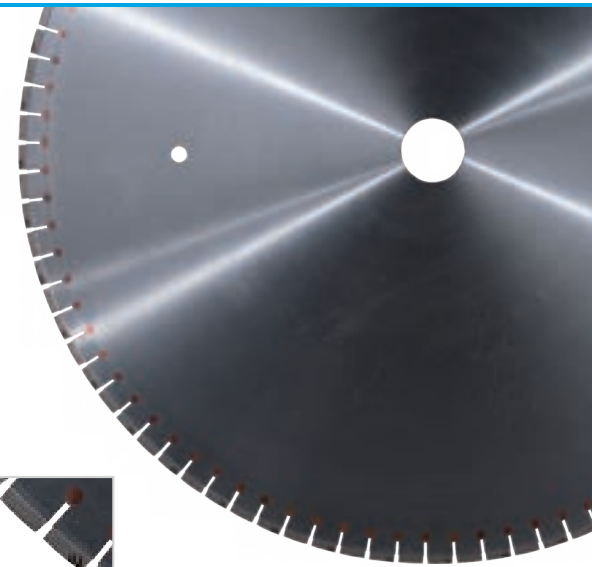

TECHNICAL DATA SHEET	
prestressed reinforced concrete	<b>SUPER</b>
	<b>EXCELLENT</b>
	<b>GOOD</b>
	<b>MEDIUM</b>
	<b>SUFFICIENT</b>
	<b>INADEQUATE</b>



AVAILABLE  
Ø 600 - 800 - 900 - 1000 - 1300 1600  
other diameters on request



# TAGLIO TRAVETTI DIECI

TAGLIO TRAVETTI DIECI is the blade designed for cutting pre-stressed reinforced concrete joists. Like the TAGLIO PREFABBRICATI DIECI, it is custom-built by analysing all the parameters of the material and the machine on which the blade is used on a case-by-case basis.

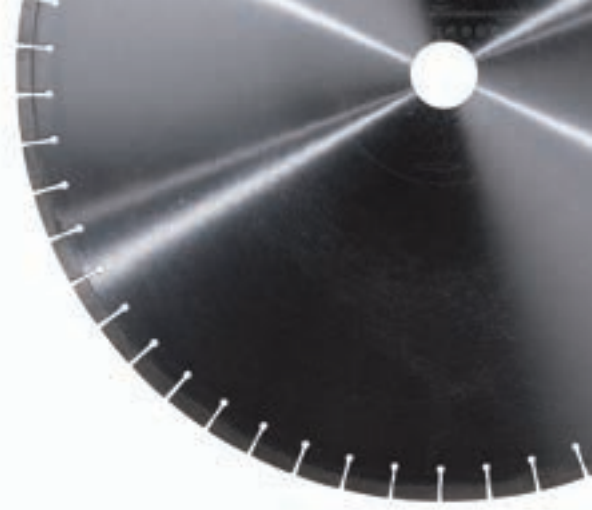

## TECHNICAL DATA SHEET

prestressed beams



**SUPER**



**EXCELLENT**



**GOOD**



**MEDIUM**



**SUFFICIENT**

**INADEQUATE**

AVAILABLE  
 Ø 600 - 800 - 900  
 1000- 1300 1600  
 other diameters on request



# SEGMENTO FORETTO SEI

The segmento foretto SEI allows controlled demolition professionals to build their own customised tool according to their needs. Constructed in various radii to suit any diameter, it guarantees fast core drilling thanks to its characteristic 'roof' shape.



## TECHNICAL DATA SHEET

reinforced concrete



**SUPER**



**EXCELLENT**



**GOOD**



**MEDIUM**



**SUFFICIENT**

**INADEQUATE**



# DECONSTRUCTION ACCESSORIES

## BOLTS SEAFX

SEAFX anchor bolts are available in various sizes to suit all construction site situations.



## SCREWS FOR MULTI-FIXING SEAFX

SEAFX multi-fixing screws are suitable for anchoring columns in any construction site situation, and are available in various lengths: 150, 200, 250, 300 and 350 mm.



## L-SHAPED SEAFX114

Female bolt for plug with spring.  
Size L - SW41



## L-SHAPED WITHOUT SPRING SEAFX115

Female bolt for plug without spring.  
Size L - SW41



## M-SHAPED SEAFX1141M

Female bolt for plug with spring.  
Size M - SW41



## M-SHAPED WITHOUT SPRING SEAFX1142M

Female bolt for plug without spring.  
Size M - SW41



## S-SHAPED WITHOUT SPRING SEAFX1143S

Female bolt for plug without spring.  
Size S - SW41



## S-SHAPED WITH SPRING SEAFX1144S

Female bolt for plug with spring.  
Size S - SW41



## MULTI-FIXING PLATE SEAFIX400

SEAFIX400 is a multi-fixing plate with a stable and secure fitting on all surfaces with only one mounting hole. It is compatible with all tripods and track systems.



## MULTI-FIXING PLATE SEAFIX450V

SEAFIX450V is a multi-fixing plate with a stable and secure fitting on all surfaces with only one mounting hole. It is compatible with all tripods and track systems. Available as SEAFIX450V vacuum- for use on exposed concrete, marble, granite - no fixing holes required.

SEAFIX450V Vacuum can be used like SEAFIX400 standard.



## LOCK NUT FOR MULTIF. PLATE SEAFIX116

SEAFIX116 is the lock nut for use with the SEAFIX400 multi-fixing plate.



## RECTANGULAR BRACKET SEALIFTL2

SEALIFTL2 is a handy rectangular lifting bracket, useful for lifting concrete parts at ground level. The concrete part must not be exposed, single-sided installation. Capacity/weight: 2 tonnes.



## ROUND BRACKET SEALIFTR2

SEALIFTR2 is a handy round lifting bracket, useful for lifting concrete parts at ground level. The concrete part must not be exposed, single-sided installation. Capacity/weight: 2 tonnes.



## LIFTING BRACKET 500 KG SEALIFTSG

SEALIFTSG is a handy lifting bracket, useful for lifting concrete parts at ground level. The concrete part must not be exposed, single-sided installation. Capacity/weight: 500 kg.



## CEILING WATER COLLECTION SYSTEM SEACEIS4

SEACEIS4 is the water collection system for ceiling 70-450 kg.



## TRIPODS SEACEI1

SEACEI1 is a tripod for the water and debris collection system for ceilings.



## DEBRIS COLLECTION SYSTEM SEACEI1

SEACEI1 is the debris and liquid collection system for the ceiling. Dimensions: 500 x 500 mm

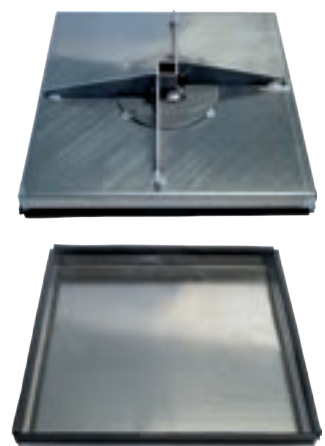



# MANDATORY DATA OF LASER MARKINGS ON DIAMOND Blades DICTATED BY EN13236

Standard EN 13236 covers the manufacture of diamond tools for the purpose of safety for their users, and has been implemented by UNI, the Italian Technical Standardisation Body

## INDELIBLE MARKING TOOLS, MANDATORY DATA FOR ALL

MANDATORY DATA	EXAMPLE
MANUFACTURER OR IMPORTER OR SUPPLIER	SEA Technology
SIZE (nominal diam.)	230
CENTRAL HOLE (in case of blades for manual machines)	F.22,23
NUMBER OF REVOLUTIONS IN M/S and RPM	80 M/S 6600 RPM
DIRECTION OF ROTATION	ARROWS NEAR THE CENTRAL HOLE
EN13236 (equivalent to a declaration of conformity)	STANDARD
RESTRICTIONS, REQUIREMENTS AND WARNINGS SYMBOLS	goggles, mask, ear muffs, hard hat, gloves, boots and do not use to sand
TRACEABILITY (to trace any production batches)	SERIAL NUMBER
INDELIBLE AND READABLE	LASER MARKING



**KEY:**

- Mandatory data
- Non mandatory data





SEA Technology is the Maxima Group's company specialising in the production and sale of diamond tools and construction machinery for professional cutting and core drilling, aimed primarily at a market of professional users, such as specialised construction equipment dealers, controlled demolition companies, industrial floor cutting companies and prefabricated building manufacturers.

For over 40 years, SEA Technology has offered its customers a personalised service and a wide range of products dedicated to professionals. One of SEA Technology's strengths is the continuous research and consequent development of new products, always aiming to meet the new demands of a constantly evolving market and characterised by high quality, guaranteed by the numerous tests carried out in-house to certify that each system complies with the most stringent regulations and fully meets the needs of the professional operator.







CARLO ANCELOTTI  
FOR

**SEA TECHNOLOGY**  
EXPERTS IN DIAMOND TOOLS, SINCE 1973



[www.seatechnology.eu](http://www.seatechnology.eu)



Via Meucci 1 42028, Poviglio – Reggio Emilia  
Tel. +39 0522 966090 - Fax +39 0522 966102  
[info@seatechnology.eu](mailto:info@seatechnology.eu) - [www.seatechnology.eu](http://www.seatechnology.eu)